

NAVIGATION AND VESSEL INSPECTION CIRCULAR NO. 4-89

Electronic Version for Distribution on the World Wide Web

Subj: Introduction to Human Factors Engineering

- Ref: (a) American Society for Testing and Materials F 1168-88, Standard Practice for Human Engineering Design for Marine Systems, Equipment and Facilities
(b) Military Standard 1472.C, Human Engineering Design Criteria for Military Systems, Equipment and Facilities

1. **PURPOSE.** This Circular introduces Human Factors Engineering (HFE) and describes and encourages its application to design, construction, overhaul, and maintenance of vessels. Areas where immediate cost effective changes can be made to improve safety and operating efficiency within the marine industry are illustrated.

2. **BACKGROUND.**

- a. **Definition.** HFE is the specialized engineering discipline concerned with ensuring systems (equipment and software) are designed to match the capabilities and limitations of the personnel which will operate and maintain them. HFE combines knowledge of human mental and physical capabilities and responses with traditional engineering principles and procedures to design machines and systems, such as ships, from the user's point of view.

HFE builds upon the disciplines of physiology, psychology, sociology, and engineering. Physiology, the science dealing with the size, shape and physical functioning of humans, provides empirical data about the human body and senses. This information is needed to ensure an appropriate physical interface between man and machine. Psychology, the knowledge derived from a careful examination of consciousness and behavior, provides information on how an individual will respond to an environment, or in a given situation. Sociology evaluates how an individual performs as a member of human society, or a member of an organization or group, such as a ship's crew. This information, when combined with knowledge from traditionally technical fields such as mechanical engineering, industrial engineering and computer science/engineering, enables the Human Factors Engineer to predict how well an individual will perform in a given environment and how to design a work environment which will enhance efficiency and safety.

A very important part of HFE is providing more effective and safer man-machine interaction. The application of HFE to the marine industry can create work environments which ensure effective work patterns contribute to improved personnel health and safety and minimize factors which degrade performance or increase human error. This is accomplished by applying structured methodologies, based on historical and empirical information, to evaluate factors such as workload, accuracy, physical stress, visual or auditory perceptiveness, and time constraints. This information would then be used to ensure that work requirements do not exceed human capabilities.

HFE is sometimes referred to as Human Factors (HF), Ergonomics, Engineering Psychology, Human Engineering (HE), Bio-technology, or Man-Machine Systems Engineering by members of the profession. Courses relating to Human Factors are offered at numerous universities and colleges leading to bachelor and advanced degrees.

- b. Components. The discipline of HFE is composed of six individual concentrations or elements, which cover a broad spectrum of physiological and psychological concerns. These six elements are:
- (1) Human Engineering (HE) - The application of human physiology and psychology to the design of equipment, work stations, consoles, controls, displays, software, and the complete system or facility.
 - (2) Biomedical - The application of biological and medical knowledge on design to promote the health, safety, protection, sustenance, escape, survival, and recovery of personnel under normal and emergency conditions.
 - (3) Manpower/Personnel - Identifies the predicted and/or acceptable range of human characteristics and the required number and skills of personnel needed to install, operate, and maintain equipment, systems, or facilities.
 - (4) Training - Identifies training requirements, develops curriculum and related instructional materials, specifies essential training aids, and designs threshold tests to provide competent personnel to operate and maintain the equipment,
 - (5) Publications/Documents - Assures operating and maintenance documentation is appropriate for the expected users.
 - (6) Test and Evaluations - Verifies that users, equipped with the appropriate instruction, tools, and documentation, can effectively and safely operate and maintain the equipment, Systems, or facilities within the full range of expected operating environments.
- c. History. The term "Human Factors Engineering" is of recent origin, first used in the 1940's. However, HFE concepts can be found in earlier works, such as Adam Smith's "Wealth of Nations" (1776), in which he described the principle of "division of labor," and Charles Babbage's "Economy of Machinery and Manufacture" (1832) which discussed methods of making workers' jobs easier. Time study experiments conducted by Frederick W Taylor (1900-1910), and time and motion studies of assembly operation by Frank and Lillian Gilbreth (1910 - 1920), became the basis for analytical tools still used today.

The 1940's and World War II brought the first great advance in HFE. As weapons systems became increasingly more complex, it was recognized poor HFE resulted in the loss of lives and poor performance. American aircraft manufacturers studied aircrew body sizes in designing bomber escape hatches and reduced accidents by changing the sizes and shapes of knobs on control handles. In 1947 what many consider to be the first HFE textbook was published, Applied Experimental Psychology (Chapanis, Garner and Morgan).

In recent history, the Department of Defense (DOD) has initiated two significant efforts in HFE to address concerns with the increased complexity of weapons systems and the decreasing number of persons entering the military. These efforts are:

- (1) HARDMAN - This study produced an analytical methodology for determining manpower, personnel, and training requirements for specific equipment and systems. The focus was to determine the education, experience, and skills required to operate and maintain existing or new equipment and systems.
- (2) MANPRINT - This effort involved the application of HFE to the material acquisition process. The focus of MANPRINT was to influence systems design during the earliest phases of life cycle system management.

Many industries have been using HFE in the design and operation of their products and systems, including: computers, automobiles, aircraft and aerospace, home appliances electronics, medical equipment and electric power companies. Human Factors Engineering is of increasing importance to the Department of Defense. The merchant marine fleet is only just beginning to make use of HFE information and technology.

- d. Professional Organizations. There are numerous professional organizations for human factors engineers and social scientists interested in the human factors field. The largest, but by no means a complete listing, are:
 - (1) The Human Factors Society
P.O. Box 1369
Santa Monica, CA 90406
 - (2) The American Psychological Association, Division of Applied,
Experimental and Engineering Psychologists
1200 17th Street, SW
Washington, DC 20036
 - (3) Systems, Man and Cybernetics Group of the Institute of Electrical and
Electronics Engineers (IEEE)
345 East 47th Street
NY, NY 10017
- e. The HFE Point of View. In the design and operation of ships and their systems, consideration is given to the interface of humans and machines. The human is the most complex component in the ship/system interface. Designing equipment or software to be used on a ship without considering the humans who will install, use and maintain them usually leads to less than an optimum match between the human and the machine. The HFE approach is a philosophy which attempts to design things from the user's point of

view by taking into account the ordinary attributes of actual users. Consideration is given to: level of education; training which will be necessary to effectively use the system; access requirements and human physical size; physical environment; human tendencies to become bored and ineffective when performing routine tasks; and the human ability to reason inductively and make decisions in unusual circumstances. HFE can be refined to a set of principles, some of which are presented in this Circular. The following four questions embody the HFE philosophy.

- (1) What does the human being do to operate or maintain the system?
- (2) What is the worst case condition under which this hardware might be operated?
- (3) What is the operating environment?
- (4) What capabilities does the operator have and/or need?

Asking these Four Questions is an assessment process. The answers may not be readily apparent but will provide information needed for HFE design and to make "tradeoff" decisions during design and construction.

3. DISCUSSION.

- a. Introduction. Advances in technology, shrinking profit margins and escalating manning costs are present trends within the marine industry. Responses to these conditions have included increased automation and decreased crew sizes. When plans for a smaller crew are included in new vessel design and construction, automated systems can be developed to compensate for the reduced manning, and a safe, efficient work environment can be created. Many owners and operators have responded to these trends by proposing reduced crew sizes on existing vessels without considering the number of people required to perform necessary normal and emergency duties. In reviewing these proposals, the Coast Guard must satisfy itself that the proposed crew reduction would not result in an unsafe working environment or an inability to respond to significant fire or flooding emergencies. The application of HARDMAN and MANPRINT by DOD, particularly the Navy, has shown that changing the crew mix or reducing crew size, without changing equipment design, may result in an inefficient and unsafe environment. This section describes how HFE may be applied to create safe and efficient working environments on new vessels and to improve safety and efficiency on existing vessels.
- b. Principal Benefits. The principal benefit of HFE is the reduction of human errors. Studies by the Coast Guard, the National Transportation Safety Board (NTSB), DOD, and international classification societies indicate 50 to 80% of all marine casualties can be attributed to procedural or other types of human errors. These errors are very costly in terms of lives lost. Aboard U.S. inspected vessels alone, there were 63 deaths in 1986 and 58 in 1987. Damage to U.S. inspected vessels and their cargo was reported at \$191 million in 1986 and \$199 million in 1987. The reduction of some human errors through the application of HFE principles has the potential of creating cost savings well worth the investment. Direct results will be increased productivity, reliability and operator usability (i.e., minimization of training and manpower costs. In addition to reduction of human error, the Naval Research Advisory Committee (NRAC) has estimated that including human elements in the initial design phases of ships and equipment could improve their effectiveness and availability by 30%, survivability by 15% and reduce the

number of casualties by 10%, while reducing personnel by 20%. The percentage of improvement within a military or commercial organization will vary; however, these figures illustrate the potential of HFE. In addition to increasing efficiency and safety, use of HFE principles will improve living and working conditions aboard ship.

- c. Uses for HFE. HFE can be applied to accomplish the following tasks. This is a partial list and is not meant to be complete.
- (1) Most advantageous arrangement and layout of the bridge or other compartments and spaces.
 - (2) Design of automation monitoring and control systems for increased usability.
 - (3) Arrangement of console panels, including identification and design of important gauges, meters and control switches.
 - (4) Sizing, positioning, shaping, and sequencing of operating levers, controls and alarm systems for maximum reliability under stress and work overload.
 - (5) Determination of manning levels for safe and efficient vessel operation.
 - (6) Determination of desired skill levels and training requirements for crewmembers, leading to better training and reduced training time.
 - (7) Providing easy to read manuals or emergency operating instructions (COW Manual, Cargo and Ballasting Manual, Stability Information, CO₂ Operating Instructions, etc.) with simple explanations and diagrams.
 - (8) Task analysis of any given operation to determine the most efficient and safe method(s).
- d. New Construction. To fully realize the benefits of HFE, design must be influenced in the earliest phases of development. Chapter 1 of enclosure (1) presents the basic design spiral, which is used in many segments of the maritime industry to depict the steps in planning the design of a new vessel. At the first planning step of the design spiral, the Mission Requirements stage, HFE should be incorporated in the planning process by citing reference (a) as -a design criteria. Reference (b) may be cited as a supplement to reference (a). At each subsequent step in the design spiral, the man-machine interface should be evaluated to ensure the creation of a safe and efficient work environment. A methodology for reviewing engineering design drawings for HFE considerations is provided in chapter 2 of enclosure (1).
- e. Improvements To Existing Vessels. Minor modifications such as changing equipment locations and operating control positions to improve human efficiency may not be cost effective on older ships. HFE principles can be incrementally incorporated on a system-by-system basis during shipyard periods when system modernization, other major modifications, or maintenance/outfitting periods are scheduled, by using the pertinent sections of references (a) and (b) in the design specifications. An area where immediate improvement in HFE can be achieved is the correction of deficient labeling. This area offers the opportunity to produce the greatest increase in

safety on existing vessels for the least cost. The extensive guidelines in reference (a) have been used to develop the information and examples in chapter 3 of enclosure (1).

- f. Application to Coast Guard Marine Inspection and Casualty Investigation. Marine inspectors can use HFE, while conducting inspections, to identify unsafe conditions. If correction of HFE deficiencies cannot be required under present regulatory authority, the inspector will probably make appropriate recommendations to the Master, Chief Engineer, Port Engineer, etc. in a manner which will encourage the use of HFE principles.

Attention should be focused on the ship/system interface as a likely cause of accidents and reasons why a system fails to operate or does not operate as designed. Investigating Officers can view all accidents from the HFE standpoint to see if there are any HFE related causal factors (contributing causes or precipitating causes, etc.). The old standby cause, "error in judgment by ... in that he/she failed to ..." may be hiding poor design, fatigue, lack of training or skill, etc., which are the root causes of the operator error. These root causes can be identified when an HFE perspective is used.

- g. Reference Publications. Although references (a) and (b) are definitive and authoritative sources of information on HFE, a wealth of additional information exists which can provide the reader with a deeper understanding of the discipline. Chapter 4 of enclosure (1) provides an abbreviated bibliography of HFE material.

4. IMPLEMENTATION.

- a. The Coast Guard welcomes industry comments from any source on the usefulness, adequacy, and applicability of this guide. Send comments to Commandant (G-MVI), United States Coast Guard, Washington, D.C., 20593-0001.
- b. Owners, operators, builders, and shipyard managers are encouraged to follow the guidelines provided in references (a) and (b) in planning modernization of older vessels and new construction. Vessel owners and shipyard Safety Engineers must be responsible for monitoring the accomplishment of HFE design and modification work. To perform this task they need to be familiar with the requirements of reference (a) and aware of the potential hazards of not adhering to its requirements.
- c. Vessel crews should take it upon themselves to identify and correct small HFE deficiencies such as labeling (marking), instruction manuals and minor rearrangement of spaces. Larger problems should be reported to company management for correction.
- d. It is recognized that some areas in present regulations conflict with HFE standards. Until these changes are made or policy is developed, regulatory requirements will continue to apply when there is a conflict. There will be many cases where HFE standards will dovetail with regulatory requirements (see the examples in chapter 3 of enclosure (1)). All interested parties are encouraged to advise Commandant (G-MVI) by letter, telephone, or other means when inconsistencies are discovered.
- e. It is further recognized that HFE guidance is limited with regard to commercial vessel casualty investigations. Commandant (G-MMI) is involved in R & D efforts focused on improving our ability to collect, store, process, analyze and apply human factors data concerning commercial vessel casualties. Results of these efforts are anticipated within a

NAVIGATION AND VESSEL INSPECTION CIRCULAR NO. 4-89

year. Incorporation into policy will follow shortly thereafter. Until then, the HFE principles introduced in this Circular should be applied to commercial vessel casualty investigations as suggested in 3.f.

A handwritten signature in black ink, appearing to read 'J. D. Sipes', with a large, stylized flourish at the end.

J. D. SIPES
Rear Admiral, U.S. Coast Guard
Chief, Office of Marine Safety, Security
and Environmental Protection

End: (1) Guide for the Application of Human Factors Engineering to Commercial Vessels

GUIDE FOR THE APPLICATION OF HUMAN FACTORS
ENGINEERING TO COMMERCIAL VESSELS

TABLE OF CONTENTS

| | |
|---|------|
| CHAPTER 1. <u>THE DESIGN SPIRAL CONCEPT</u> | 1-1 |
| CHAPTER 2. <u>HUMAN FACTORS ENGINEERING PLAN REVIEW</u> | |
| A. Introduction | 2-1 |
| B. Preliminary and Detail Design Engineering Drawings | 2-1 |
| C. Vendor Hardware Drawings | 2-3 |
| D. Sample Data Input Sheet | 2 - |
| CHAPTER 3. <u>ASTM F 1166-88 LABELING OVERVIEW</u> | |
| A. Introduction | 3-1 |
| B. Reader Familiarity | 3-1 |
| C. Brevity | 3-1 |
| D. Format | 3-1 |
| E. Characters and Numbers | 3-2 |
| F. Location | 3-2 |
| C. Label Classifications | 3-3 |
| G.1. Hazard Marking Guidelines | 3-3 |
| G.2. Introduction Marking Guidelines | 3-11 |
| G.3. Identification Marking Guidelines | 3-5 |
| G.4. Information Marking Guidelines | 3-5 |
| G.5. Graphic Plate Marking Guidelines | 3-5 |
| H. Label Examples | 3- |
| H.1. Introduction | 3-4 |
| Example 1 | 3-7 |
| Example 2 | 3-7 |
| Example 3 | 3-8 |
| Example 4 | 3-8 |
| Example 5 | 3-9 |
| Example 6 | 3-9 |
| Example 7 | 3-12 |
| CHAPTER 4. <u>BIBLIOGRAPHY OF REFERENCE MATERIALS</u> | |
| A. Private Publications | 4-1 |
| B. Military Publications | 4-2 |
| C. Federal Publications | 4- |
| D. Abbreviations Used in This Enclosure | 4- |

CHAPTER 1. THE DESIGN SPIRAL CONCEPT

Design must be influenced in the earliest phases of development to realize the full benefits of HFE. The design spiral, as presented by J. H. Evans in the November 1959 "Naval Engineers Journal", is used within the maritime industry to describe the iterative steps leading to the development of a detailed ship design. The first planning step of the design spiral, at the top of the outer circle, is to determine the Mission Requirements. These are operating or construction requirements which may be given by the owner, determined by vessel service and route, or mandated by regulation. HFE should be incorporated in the planning and designing process by citing HFE design criteria at this stage. The design team is then led inward along the spiral. At the intersection of the spiral with each radial line, major aspects of the future vessel are considered and developed. The analysis proceeds at a conceptual level until the spiral once again intersects the Mission Requirements radial line. At this point, the design team checks to make sure the future vessel, as described in the preceding steps, continues to fulfill the Mission Requirements. The man-machine interface should be evaluated to ensure the creation of a safe and efficient work environment. The design team continues to increase the level of detail at each of the smaller concentric rings, revalidating or changing each design element as necessary, and further refining the design. A point to remember is that if HFE is incorporated into conceptual design, important changes can be easily made which will increase the efficiency and monetary savings by a much larger magnitude than if HFE is only included at the detail design level.

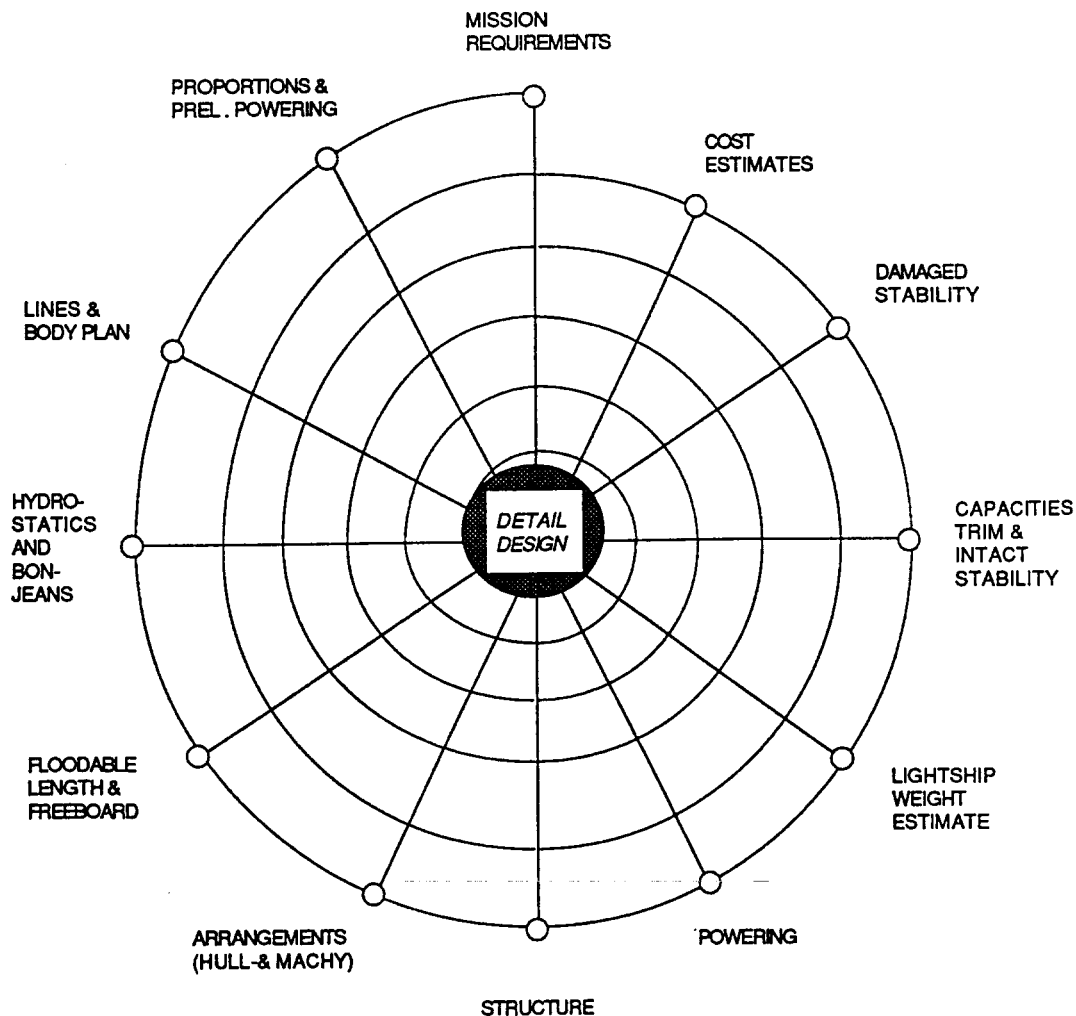

CHAPTER 2. HUMAN FACTORS ENGINEERING PLAN REVIEW

A. INTRODUCTION. This enclosure gives a standard methodology for HFE review of engineering drawings (or plans) produced in the design and construction of ships and their individual components and systems.

HFE plan review during initial design provides the most timely and cost effective way to ensure that HFE design requirements are included in space arrangements and finished hardware. Approximately 40 to 45% of all HFE inputs are made during the plan review effort.

HFE plan review is a thorough inspection of engineering drawings to make sure the intended design has considered the human who will interact with the equipment or system, and to ensure the drawing complies with HFE specification requirements. HFE plan review requires knowledge of Human Factors Engineering design standards and the ability to complete a detailed evaluation of each item presented on the drawing or plan.

During the design and construction' of a large vessel it is quite possible to generate up to two thousand drawings. Experience has shown that only 12 to 15% of these drawings need HFE Plan Review. Most construction drawings, including wiring, piping and other systems, containing information on fabrication methods, material specifications, welding details, etc. do not need HFE review because no constructive input can be made. However, Layout and Arrangements of all spaces (quarters, work spaces, bridge, engine rooms and auxiliary machinery spaces) including location and layout of piping and wiring, console or work station panel layout drawings, and individual equipment design drawings should be reviewed from the HFE perspective.

The specific approach to reviewing a drawing depends largely upon the reviewer's HFE experience and the type of drawing being reviewed. The following is an approach for new ship design contracts which has been successful in the past.

B. PRELIMINARY AND DETAIL DESIGN ENGINEERING DRAWINGS

1. During the first plan review, each piece of equipment, furniture, etc. found on the materials list should be labeled on the drawings. This includes the sections and elevations.
2. Scaled dimensions should be labeled on plans, sections and elevation plans for all areas of interest from an HFE perspective. For example, the horizontal clearances between equipment, furniture, etc., the depth of a desk or table requiring the user to reach the back, the width of a walkway, or the diameter of an access opening.
3. Start the review at a well defined point on the plan. Take each item on the plan and ask three questions (note that the Fourth HFE Question listed on page 4 does not apply to plan review):
 - a. What are the tasks required of the person operating and maintaining this item?
 - b. What are the worst possible circumstances under which people might be required to use the item?
 - c. What are the expected environmental conditions under which the item might be used?

To answer these questions, additional assistance may be required from various personnel or resources such as: the design engineer; manufacturer's catalog; technical manuals; ship's crew; or a personal inspection of an existing item or component.

4. Any design deficiencies or design criteria omissions found should be marked in red at the appropriate location on the drawing. Unanswered questions should be marked on the drawing, in some other color, as a reminder for later drawing revision reviews.
5. Wherever possible, indicate the specific HFE design criteria desired directly on the plan (i.e., dimensions, relocation of equipment, etc.). Negotiate changes if necessary.
6. HFE data input sheets should be used to record each change indicated on the design drawings. A copy of this data input sheet, and a "marked-up" plan should be provided to the person responsible for preparing the drawing. The person receiving the copy should review and indicate on the data input sheet which have been accepted (Y) and which were rejected (N) and provide a brief explanation. After the review, the plans and data input sheet should be returned to the HFE reviewer. This negotiation process should continue until a final resolution has been reached (a sample data input sheet is shown on page 2-4).
7. Subsequent revisions and reviews of each drawing must be completed to ensure:
 - a. Previously accepted HFE changes have been made.
 - b. HFE changes made on earlier revisions have not been removed.
 - c. Engineering changes made on the plan necessitating its resubmittal have not introduced new HFE problems (any found should follow the process stated above).
8. A log should be kept of all HFE data input sheets. These are extremely useful when completing subsequent reviews.
9. Due to the level of detail required and the complexity of most drawings, a tracking system is usually required to document deficiencies and monitor their resolution.

C. VENDOR HARDWARE DRAWINGS.

1. Vendor (or subcontractor) drawings usually cover only a single piece of equipment. Therefore, the reviewer should look for such things as: location of maintenance points for accessibility after installation; size, location and content of labels; placement of the unit's controls and displays; weight of removable parts; and obvious safety hazards.
2. If technical manuals are available, they should be reviewed against the drawings to ensure the visual aids in the manuals correspond with the drawings.
3. Any HFE deficiencies found should be recorded and handled in the same manner as were those identified on the engineering drawings.

D. SAMPLE HFE DATA INPUT SHEET.

HUMAN FACTORS ENGINEERING (HFE)
DATA INPUT SHEET

SUBJECT: RADIO ROOM LAYOUT
DRAWING NO. _____ SHEET NO. _____ DOCUMENT CONTROL NO. _____

HFE DESIGN INPUT(S):

- (N) 1. I question the need for the loudspeakers in the overhead since there are radio jackboxes between each radio operator position. Question: Do we need the speaker AND jackboxes? Also move the loudspeakers (item #30) from the overhead and mount them on the BKHD in front of the radio operators. (Speakers and jackboxes both required by ship specification. Cannot put on FWD BKHD due to lack of space but will move FWD in overhead so they are directly over each operator.)
- (N) 2. Put sound absorbent partitions between the radio operators and make them 30" high. (Not called for in the ship specification.)
- (N) 3. Raise the status boards (item #21) six inches. (Can only go 5" before hitting HVAC duct - but will raise them that much.)
- (Y) 4. Move the bookrack (item #7) from its current location to the STBD, FWD corner of the room and face it inboard.
- (Y) 5. Rotate the teletypewriter (item 12) 90 degrees so the operator will face forward when sitting at the keyboard.

/s/

Note: (1) This sheet is prepared from an HFE plan review of an arrangement of the RADIO ROOM. The designer's response to HFE requested changes are shown in parentheses.

- (2) The contents of this form are typed for this paper. In actual use the information is handwritten.

CHAPTER 3. ASTM F 1166-88 LABELING OVERVIEW

A. INTRODUCTION. HFE provides the perspective necessary to successfully communicate with people by taking into consideration how people receive and interpret messages (i.e., physiologically and psychologically). Among the numerous publications providing HFE guidelines, reference (a), ASTM F 1166-88, Standard Practice for Human Engineering Design for Marine Systems, Equipment and Facilities, is highly regarded within the HFE community. This publication contains a wealth of information and data which can be used to improve safety, productivity and efficiency aboard ships.

Throughout this Circular the terms "label" and "marking", which is a more familiar term aboard ship and in Coast Guard regulations, are used interchangeably and mean any type of sign, placard, inscription, or legend used for identification or to impart information or instructions.

What follows is a synopsis of the techniques for labeling which are contained in the ASTM specification. Examples follow which were taken from observations aboard commercial vessels and the Code of Federal Regulations. These techniques and examples can be used to increase the readability and effectiveness of labels.

B. READER FAMILIARITY

1. Consistency in format, color, location, etc. of markings throughout the ship or fleet increases reader familiarity.
2. Markings must always use words, symbols and abbreviations familiar to the intended reader. Abbreviations should be standardized and used consistently. Punctuation is not required after an abbreviated word or phrase.
3. Trade names, company logos, or other information not directly required by the user should not be used on markings.

C. BREVITY. Markings should be as concise as possible without distorting the intended meaning. Information should be unambiguous and convey a clear message to the intended reader. Only relevant information is needed. Avoid redundancy in words and phrases, and excessive detail. However, brevity should not be stressed to the point of making the message difficult or impossible to decipher.

D. FORMAT.

1. All markings of the same type should be consistent in format and in the presentation of information.
2. Use headings and subheadings to identify groups of related information. The subheadings and headings should have increasingly larger character sizes than the text, but smaller size than the title.
3. Well designed markings are concise and self-contained. Supplemental information may be identified by footnote.
4. Safety and/or hazard information mixed in with other information such as instructions must be distinctly differentiated, clearly stated, easily identified and readily visible to the reader.

E. CHARACTERS AND NUMBERS.

1. The background color of markings should contrast with the surface to which they are affixed.
2. Do not use reflective or glossy materials for lettering or backgrounds.
3. Use a block type letter style and all capital letters for: subheadings; signal words such as DANGER, CAUTION, ATTENTION, NOTICE, etc.; and short messages. Capital and lower case letters can be used for extended sentence messages where punctuation is necessary.
4. Letter and number widths are largely a function of their height. Generally, their width should be 3/5 of the height.
5. Word and line spacing guidelines call for word separation to be a minimum of one character to three and one half characters.
6. Line spacing is a little more complex. The minimum space between lines should be one half character height.
7. Minimum character height should conform to the values in the table below for the given expected viewing distances:

| <u>Viewing Distance</u> | <u>Minimum Height</u> |
|-------------------------|-----------------------|
| < 3 feet | .17 inch |
| 3 - 6.5 feet | .36 inch |
| 6.5 - 13 feet | .75 inch |
| 13 - 26 feet | 1.50 inch |

NOTE: This recommended minimum letter height applies to the smallest lettering used. Larger lettering should be proportionally larger than the minimum letter size.

8. Letter and number combinations which should be avoided are: the number 1 with the letters L or I; and the number zero with the letters O or Q.

F. LOCATION.

1. Put markings in highly visible locations.
2. Put markings in consistent locations throughout the ship and from system to system.
3. Do not group four or more markings together, and avoid groupings of two or three. If a grouping of two or three must be used, arrange the markings by type and in a priority which allows hazard information to be seen first, then instructions, and then information.
4. Mount graphic plates (i.e., diagrams) adjacent to the matching instructions or explanation.

5. Mount identification markings to ensure maximum visibility and immediately adjacent to the item which is identified. Markings on bulkheads or other ship structures for identification of adjacent valves, machinery or other equipment can be, and are, easily painted over and should be avoided if possible.
6. Markings which have been preinstalled on items should be visible and legible after the item is in place.
7. For greatest visibility, place markings on flat surfaces.

G. LABEL CLASSIFICATIONS. Label (or marking) types are determined by the messages which they convey. In addition to the general requirements of construction, each type has its own set of guidelines as well. There are five basic types: Hazard; Instruction; Identification; Information; and Graphic. The following paragraphs give special guidelines for each type.

1. Hazard Marking Guidelines.

- a. Hazard markings are specific in nature. They are important because they convey information and instructions concerning existing or potential situations which may be hazardous to a ship's personnel or equipment. Provide these markings wherever it is necessary to minimize the possibility of injury to personnel, damage to equipment or systems, or call for special precautions. Locations where hazard markings can be used are: fixed physical obstructions; moving or rotating equipment; radiation hazards; toxic fumes or chemicals; high voltage; and safety equipment or clothing requirements.
- b. A signal word, or attention getter, is used to warn of a hazard. Hazard markings should contain only one of the two signal words HFE experts consider valid for hazard warnings. The degree of seriousness of the hazard characterizes the difference between these two. Select the appropriate signal word as follows:
 - (1) DANGER - is used to identify and provide information about a situation where an action or a failure to act on the part of the crew member could result in serious injury or death, serious damage to vital equipment or a major reduction in the ships capability to operate.
 - (2) CAUTION - is used to identify and provide information about a situation where an action or a failure to act on the part of the crew member could result in a minor injury, minor damage to equipment, or a minor reduction in the ship's capability to operate.
- c. Signal word lettering should be at least 50% larger than the text found in the lower component.
- d. When developing markings warning about safety hazards, HFE requires three questions to be answered. The answers to these questions provide the basic information which must be conveyed in the intended message. After the signal word the marking should contain three brief statements in response to these questions:

- (1) What is the Hazard? E.g., HIGH VOLTAGE (if there is more than one hazard, list them in order of severity).
 - (2) What are instructions for avoiding the hazard? E.g., STAY OUTSIDE RED LINES (if more than one instruction, list them step-by-step).
 - (3) What are the potential consequences if instructions are not followed? E.g., ELECTROCUTION POSSIBLE.
- e. DANGER markings should have white lettering on a red background. This contrasting color combination (light on dark) offers the best visibility under poor lighting conditions. CAUTION markings should have yellow characters on a black background.

2. Instruction Marking Guidelines

- a. These are markings used to present step-by-step instructions for accomplishing a specific task (operation or maintenance related), and to provide hazard and safety information related to performing the task.
- b. Instructions need only be provided when:
 - (1) It is likely untrained personnel will be operating or maintaining equipment critical to the survivability or operation of the ship.
 - (2) When little or no training is provided and the equipment is authorized for general use by all personnel.
 - (3) The operation or maintenance procedures are lengthy or complex, and it is likely manuals and or documents will not be available.

Instructions should be organized to reflect this unfamiliarity or lack of training.

- c. Instruction markings should be titled at the top with either Operating Instructions for xxxxxx or Maintenance Instructions for xxxxx or both. Any hazard or safety information relating to the general task should come before the instructions and should be given the appropriate signal word (DANGER or CAUTION).
- d. Titles should be at least 50 percent larger than subheadings and subheadings at least 25 percent larger than the text.
- e. Within the text use numbered step-by-step instructions. Each instruction should be brief. Equipment model names or numbers etc. should be avoided due to equipment or system changes in the future. Hazard and safety information pertaining to a specific instruction should proceed the instruction and be identified with the appropriate signal word (DANGER or CAUTION).
- f. Instructions should be provided separately from diagrams, schematics, charts or other graphic plates.

- g. If operating instructions and maintenance instructions are provided on the same sign, the operating instructions should appear first and each group of instructions should be given the appropriate heading.

3. Identification Marking Guidelines These are used specifically for identification purposes and do not require any additional construction guidelines. Examples of this type marking are:

Spaces, e.g., Paint Locker, State Room, Gyro Room.
Locations, e.g., Fire Station #1.
Equipment/Function, e.g., Air Compressor, Feed Water Pump.
System, e.g., Cargo Transfer.
Controls, e.g., On/Off, Standby, Reverse.
Displays, e.g., Radar.

4. Information Marking Guidelines.

- a. These are used to present nonprocedural information of a general nature which contributes significantly to general safety or operational capability of the vessel, e.g. rules of conduct, health, first aid, sanitation, housekeeping, etc.
- b. Information labels are not to be used in place of hazard or instruction labels.
- c. Information Markings should have two components: an upper one containing an appropriate signal word such 'as ATTENTION or NOTICE (whichever is chosen should be used consistently throughout the vessel); and a lower containing text. The signal word should be 50 percent larger than the headings, and headings should be at least 25 percent larger than the text.

5. Graphic Plate Guidelines.

- a. Graphic plates are diagrams, schematics, charts, etc. and should be used only when absolutely necessary or required.
- b. Like all markings, graphics should have titles at the top. The title should describe the equipment, system, or information being presented. Adjacent graphics should have separate titles which clearly delineate them.
- c. All graphic symbols, and special nomenclature used should be defined in a legend. Text should be as brief as possible and should not obscure or congest the graphic depiction. Graphics should also indicate the location and orientation of the equipment or system aboard the ship.
- d. All graphics of the same type or for the same purpose should utilize the same format.
- e. Character sizing should follow the general rule of titles (titles 50% larger than headings and heading 25% larger than the text).

H. LABEL EXAMPLES

1. Introduction. The Code of Federal Regulations mandates the use of certain markings aboard marine vessels. These regulations often contain language which requires the reader to interpret and decide what is necessary to meet the regulation (e.g., conspicuous place; normally accessible and clearly marked). Using HFE principles simplifies these interpretations and decisions and brings the intended message into focus. Consider the following:

| <u>Current CFR Language</u> | <u>HFE specific language</u> |
|-----------------------------|---|
| conspicuous place | <ol style="list-style-type: none"> 1. A location no higher than 80 inches, nor lower than 24 inches above the deck. 2. A Location within 60 degrees vertical and 30 degrees horizontal from the readers normal line of sight. |
| normally accessible | <ol style="list-style-type: none"> 1. A location within the reach of the 10 percentile female to the 90 percentile male. 2. A location reachable by the full range of user sizes without leaving the normal work station. |
| clearly marked | <ol style="list-style-type: none"> 1. Marked so as to be readable by a person with no higher than an 8th grade education, from at least 15 feet, under bright lighting. 2. Marked so as to be read and understood by all of the crew anticipated to be on the ship. |

2. The following examples, selected from merchant vessels, illustrate improvements which can be made to existing markings, mandatory or discretionary, through the application of HFE principles.

Example 1

Marking development should proceed in steps. First establish the content. Then determine how the marking should actually look to the reader (format, signal words, capitalization, etc.). For example, take any piece of machinery with a rotating shaft (cargo pump, generator, etc.).

1. What is the hazard? ROTATING MACHINERY
2. How do you avoid it? STAY CLEAR
3. What are the consequences if you ignore the marking?
DEATH OR SERIOUS INJURY

The HFE principles used in developing this marking would be:

- * indications of the severity of the safety hazard through the use of the signal word DANGER.
- * color contrast should be white letters on a red background.
- * capitalization of letters.
- * brevity.
- * no unfamiliar abbreviations, symbols or language.

- * letter size would be determined by the maximum anticipated distance at which the smallest line needs to be read. The signal word should be at least 50% larger than the second line.
- * the marking should be displayed near the center (lengthwise) of the rotating shaft.

The result would look and read as follows:

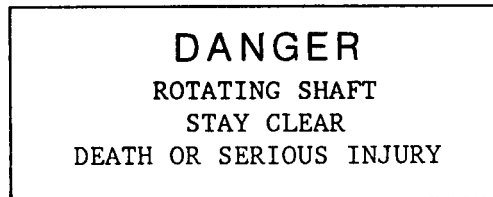

Example 2

Current regulations in be clearly marked with OUT". This regulation information from being HFE enhancements could 46 CFR 35.05-15(e)(ii) require all cargo hatches to not less than 3 inch high letters "DANGER - KEEP does not, however, restrict the use of additional provided with the required marking. The following be made to improve its effectiveness.

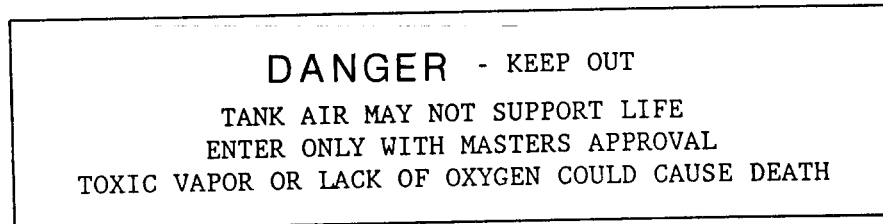

Note: Normally only signal words occupy the first line. Regulations require nonstandard format.

This clarifies the severity of the hazard, tells what the hazard is, what to do to avoid the hazard, and the consequences of ignoring it. The color and shape should be consistent with other DANGER markings on board. The regulation requires the first line to have letters at least 3 inches

Example 3An Observed Label
(discretionary)

BEFORE ENTERING PUMP ROOM
FAN ON 30 MINUTES BEFORE ENTRY
STANDBY MAN ON TOP
NOTIFY MATE ON WATCH

HFE Label

DANGER
PUMP ROOM AIR MAY NOT SUPPORT LIFE
RUN FAN 30 MINUTES BEFORE ENTERING
PLACE STANDBY MAN ON TOP
NOTIFY MATE ON WATCH
TOXIC VAPORS OR LACK OF OXYGEN COULD CAUSE DEATH

These markings emphasize the need for activity prioritization within a hazard marking. The reader is told how severe the impending safety hazard is; what the hazard is; each activity which must be carried out to avoid the hazard and what will happen if the activities are ignored.

Example 4

A dangerous deckhouse hatchway was observed. Numerous injuries had occurred, some of which were serious. No markings were found in the area alerting crew members to a hidden obstruction on the other side of the entrance. This type of an accident can be reduced by simply adding the following recommended marking:

CAUTION
HIDDEN PIPE
STEP WIDE
TRIPS SLIPS AND FALLS POSSIBLE

This hazard is not severe (relatively), but could result in personal injury, so the signal word CAUTION is used. Answering the three questions for a safety hazard provides the remaining message. The marking should be stenciled on the weather deck bulkhead (i.e., on the outside of the hatch) where it will never be obstructed when the hatch door is open. The smallest letter size should be a minimum of .17 inch to allow the marking to be read from three feet.

Example 5

The discretionary marking below (on the left) was observed on the inside of a hatch leading to the weather deck. It is confusing because it attempts to convey several messages to the reader. It also contains information which does not need to be included in a warning (i.e., air conditioning keep door closed). The marking on the right better defines and identifies for the reader the potential hazards, what must be done to avoid the hazards, and the consequences of ignoring the warning.

An Observed Label
(discretionary)

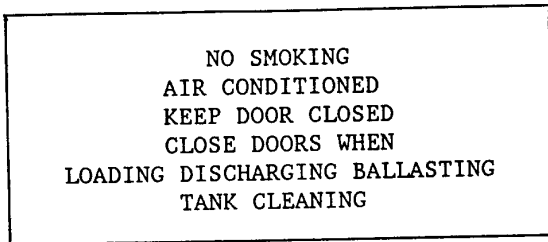

HFE Label

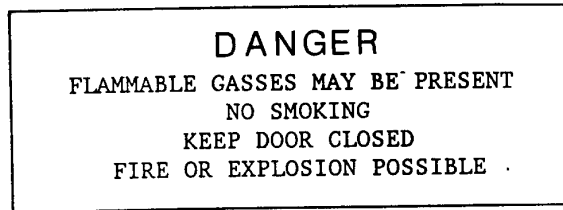

Example 6

Two examples of instructions for steering gear changeover (with diagrams) are on the following pages. Example A provides all relevant information necessary to complete the task, but it does not follow the general guidelines for Instructions (step-by-step instructions, hazard information provided prior to the step involving the hazard, etc.).

Example B is a better example of how an instruction marking should look and read. Each instruction is in a step-by-step organization, identifies each component required to execute the step, and indicates its location on the system drawing. It is concise and clear. It also provides relevant hazard information prior to the step discussed.

EXAMPLE A
An Observed Label

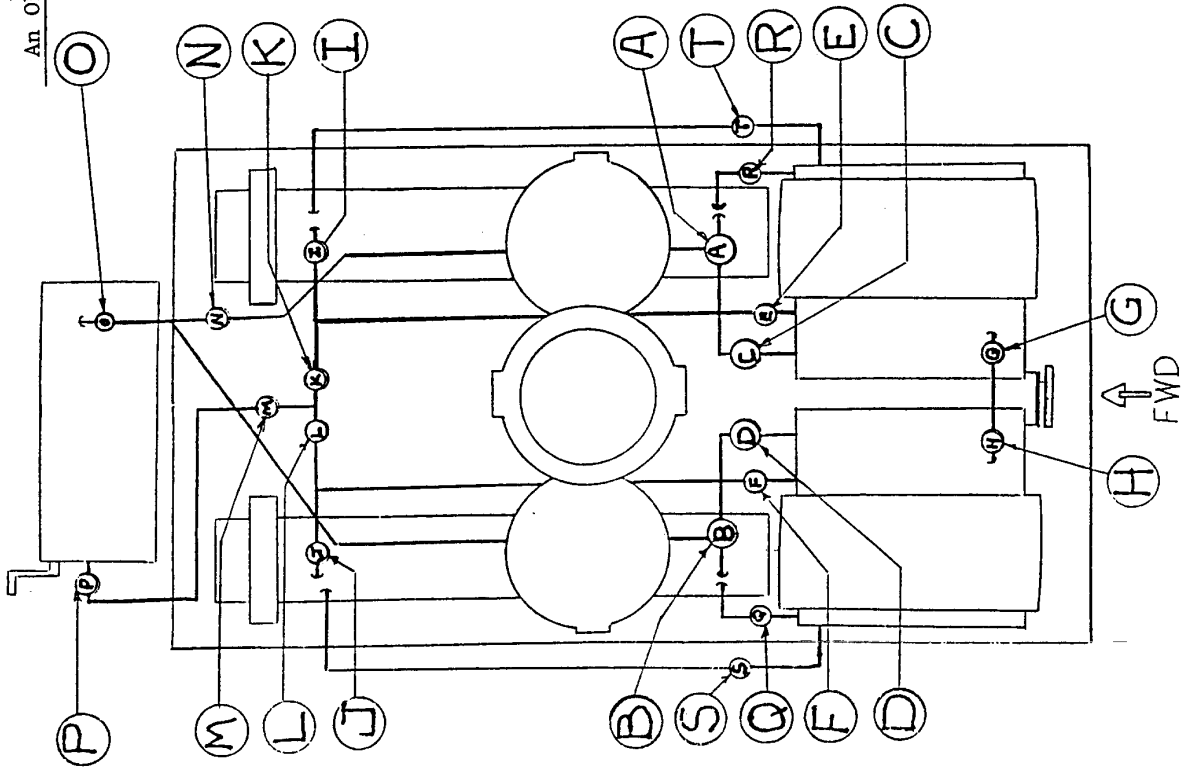

INSTRUCTIONS FOR CHANGING STEERING GEAR OPERATIONS

CAUTION: STEERING WHEEL AND RUDDER MUST BE LINED UP AMIDSHIPS BEFORE CHANGING OPERATIONS

| STEERING WITH | MOTOR CONTROLLER | VALVES OPEN | VALVES CLOSED |
|---------------------|------------------------------------|--|---------------|
| STARBOARD PUMP ONLY | Stbd <u>ON</u> Port <u>OFF</u> | Q, S, H, G | D*, F*, L, I |
| PORT PUMP ONLY | Stbd <u>OFF</u> Port <u>ON</u> | R, T, G, H | C, E, K, I |
| HANDPUMP | Stbd <u>OFF</u> Port <u>OFF</u> | O, P, M**, L**, K**, J**, I**, N, A, B | C, D, E, F |

* **DANGER!** VALVES D AND F MUST BE CLOSED BEFORE OPENING VALVES Q AND S. PERMANENT DAMAGE TO THE PORT PUMP CAN RESULT IF THESE INSTRUCTIONS ARE NOT FOLLOWED

** **CAUTION!** VALVES J AND I SHOULD BE OPENED AFTER VALVES M, L, AND K. OPENING BEFORE COULD CAUSE DAMAGE TO THE HYDRAULIC RAMS

EXAMPLE B
HFE LABEL

INSTRUCTIONS FOR CHANGING STEERING GEAR OPERATIONS

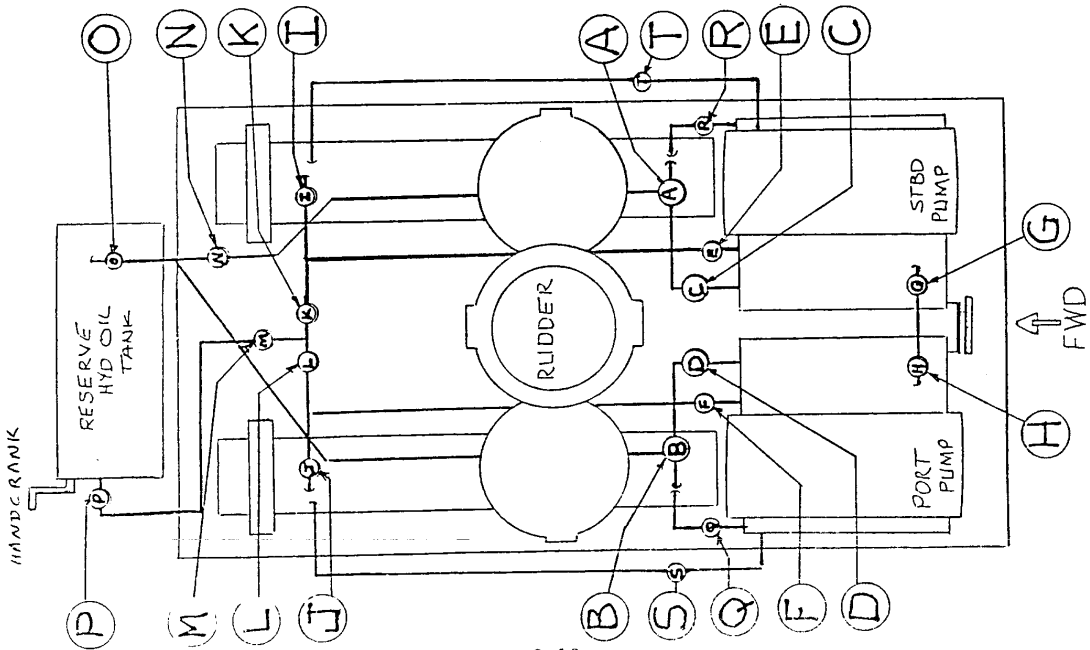

CAUTION: STEERING WHEEL AND RUDDER MUST BE LINED UP AMIDSHIPS BEFORE CHANGING OPERATIONS

EMERGENCY CONDITION: PORT PUMP FAILURE

1. SHUT OFF POWER TO PORT PUMP AT MOTOR CONTROLLER LOCATED ON AFT BULKHEAD DIRECTLY BEHIND PUMP. LEAVE STBD PUMP RUNNING
2. CLOSE VALVES **(D)** AND **(E)**

DANGER: VALVES **(D)** AND **(E)** MUST BE CLOSED BEFORE OPENING VALVES **(Q)** AND **(S)**. PERMANENT DAMAGE TO THE PORT PUMP CAN RESULT IF INSTRUCTIONS ARE NOT FOLLOWED

3. OPEN VALVES **(Q)** AND **(S)**
4. CHECK TO MAKE SURE THAT VALVES **(L)** AND **(I)** ARE CLOSED
5. OPEN VALVES **(H)** AND **(G)**

EMERGENCY CONDITION: STBD PUMP FAILURE

1. SHUT OFF POWER TO STBD PUMP AT MOTOR CONTROLLER LOCATED ON AFT BULKHEAD DIRECTLY BEHIND PUMP. LEAVE PORT PUMP RUNNING
2. CLOSE VALVES **(C)** AND **(E)**

DANGER: VALVES **(C)** AND **(E)** MUST BE CLOSED BEFORE OPENING VALVES **(R)** AND **(T)**. PERMANENT DAMAGE TO THE STBD PUMP CAN RESULT IF INSTRUCTIONS ARE NOT FOLLOWED

3. OPEN VALVES **(R)** AND **(T)**
4. CHECK TO MAKE SURE THAT VALVES **(K)** AND **(I)** ARE CLOSED
5. OPEN VALVES **(G)** AND **(H)**

EMERGENCY CONDITION: BOTH PUMPS FAIL

1. SHUT OFF POWER TO THE PORT AND STARBOARD PUMPS AT THE MOTOR CONTROLLERS ON THE AFT BULKHEAD DIRECTLY BEHIND THE PUMPS
2. CLOSE VALVES **(C)** AND **(D)**
3. CLOSE VALVES **(E)** AND **(F)**
4. OPEN VALVES **(P)** AND **(O)**
5. OPEN VALVES **(H)**, **(L)** AND **(K)**

CAUTION: VALVES **(J)** AND **(I)** SHOULD ONLY BE OPENED AFTER VALVES **(R)**, **(L)** AND **(K)** OPENING BEFORE COULD CAUSE DAMAGE TO THE HYDRAULIC RAMS

6. CHECK TO MAKE SURE VALVES **(J)** AND **(I)** ARE OPEN
7. OPEN VALVE **(N)**
8. CHECK TO MAKE SURE VALVES **(A)** AND **(B)** ARE OPEN
9. REMOVE HANDCRANK FROM STORAGE ON FRONT OF RESERVE HYDRAULIC OIL TANK.
10. ATTACH HANDCRANK TO THE SHAFT LOCATED AT THE PORT, FORWARD CORNER OF THE RESERVE TANK
11. ROTATE HANDCRANK IN A CLOCKWISE DIRECTION FOR RIGHT RUDDER MOVEMENT. ROTATE HANDCRANK COUNTER CLOCKWISE DIRECTION FOR LEFT RUDDER MOVEMENT

Example 7

Even when Instructions are presented in step-by-step format, they can still be difficult to read (see Example C below for launching a lifeboat).

Instructions must be brief, yet provide all the necessary information in the proper sequence while alerting the reader to any probable-safety hazards. Example D (next page) provides much clearer step-by-step instructions needed to accomplish the successful launching of a lifeboat. It provides cautionary statements prior to each applicable step, and illustrates with a simplified drawing the general location of many of the components necessary to launch the lifeboat.

EXAMPLE C
An Observed Label

INSTRUCTIONS FOR THE GRAVITY DAVIT
LAUNCHING OF A LIFEBOAT

1. Remove boat cover and its supporting ridgepole. Put cap on drain. Lead sea painter forward, and make fast outboard and clear of all obstructions.
2. Release gripes.
3. Raise winch brake handle, and davits with suspended boat should roll to the outboard position. Lower away to embarkation deck. The tricing pendants will bring the boat to the side of the ship. The brake should be put on before the tricing pendants take all the weight.
4. Before passengers and crew enter the boat at the embarkation deck, frapping lines should be passed and hove taught. With all aboard boat seated, the trip hooks on the tricing pendants should be released and the boat eased outboard by slacking frapping lines. Releasing the tricing pendants without observing these precautions will allow the boat to swing out violently, risking a spill of occupants over the side.
5. With the boat in the outboard position, it may be lowered into the water and released.
6. When the boat is in the water, the lifeboatman in charge should turn the releasing gear. Boat can then be held alongside with painter so that men who remained aboard to lower can climb down a ladder into boat to abandon ship.

EXAMPLE D
HFE LABEL

INSTRUCTIONS FOR THE GRAVITY DAVIT
LAUNCHING OF A LIFEBOAT

1. Remove boat cover and its supporting ridgepole (A).
2. CAUTION: Drain cap must be in place for boat to float. Put caps on drain holes (B) in bottom of boat before launching starts.
3. Check to make sure sea painter is led forward, inboard of the falls. Sea painter should be outboard and clear of all other obstructions.
4. Release gripes (C).
5. CAUTION: Boat will roll outboard when brake is released. Raise winch brake handle and allow boat to roll downward to the outboard position.
6. CAUTION: Set brake before tricing pendants take all of the weight of the boat. Lower to embarkation deck (E). Tricing pendants (D) will bring boat to the side of the ship.
7. CAUTION: Frapping lines (F) should be passed and made taut prior to embarking occupants. Seat occupants. Hang on to manropes and lifelines.
8. CAUTION: Keep frapping lines taut while releasing the trip hooks of the tricing pendants (G). Occupants could be spilled by the violent swinging. Release trip hooks on tricing pendants.
9. Ease boat outboard by slacking frapping lines.
10. DANGER: Operating the releasing gear before the boat is in the water will drop the boat from the falls and cause severe injury or death. Once outboard, lower boat into the water.
11. CAUTION: After the boat is in the water and released from its falls, any swinging of the floating blocks (H) will be dangerous to the boat occupants. Disconnect the boat from its falls by operating the releasing gear.
12. Those lowering boat can descend while boat is held alongside with painter.
13. Release the sea painter only after those who have lowered boat are aboard.

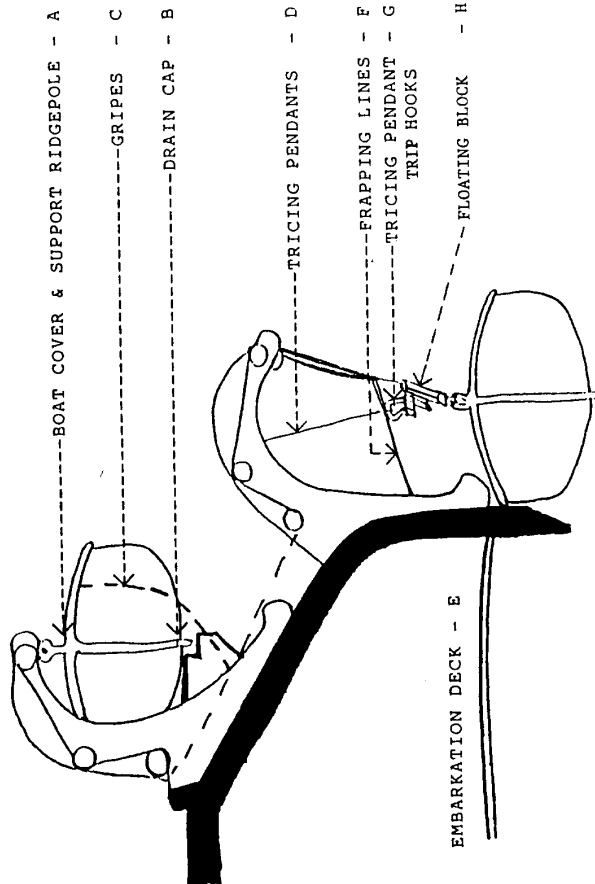

3-14

CHAPTER 4. BIBLIOGRAPHY OF REFERENCE MATERIALS

A. PRIVATE PUBLICATIONS

American National Standards Institute (ANSI). 1430 Broadway, New York, NY 10018.

| | |
|----------------|--|
| ANSI S1.1 1860 | Acoustical Terminology |
| ANSI 51.4 | Sound Level Meters |
| ANSI S1.6 1967 | Preferred Frequencies and Band Numbers for Acoustical Measurements |
| ANSI S3.2 1960 | Monosyllabic Word Intelligibility, Method for Measurement of |
| ANSI 53.5 1969 | Articulation Index, Methods for the Calculation of |

American Society for Testing and Materials (ASTM). 1916 Race Street, Philadelphia, PA 19103.

| | |
|------------------|---|
| ASTM E 380-76 | Standard for Metric Practice |
| ASTM F 1166-88 * | Standard Practice for Human Engineering Design for Marine Systems, Equipment and Facilities |

Boff, KR., Kaufman, L., and Thomas, J.P. (eds.), Handbook of Perception and Human Performance. Volume I: Sensory Processes and Perception, Volume II: Cognitive Processes and Performance. New York: Wiley, 1986.

Helander, M. (ed.), Handbook of Human-Computer Interaction. Amsterdam: North-Holland, 1988.

International Organization for Standardization (ISO). 1430 Broadway, New York, NY 10018. DIS 2631 Guide to the Evaluation of Human Exposure to Whole Body Vibration

Norman, Donald A., Psychology of Everyday Things. New York: Basic Books, Inc., 1988.

* USED EXTENSIVELY FOR LABEL AND TECHNICAL MANUAL DISCUSSIONS

Society of Automotive Engineers (SAE), 400 Commonwealth DR, Warrendale, PA 15096-0001.

| | |
|----------|---|
| SAE J925 | Minimum Access Dimensions for Construction and Industrial Machinery |
| | Woodson, WE., <u>Human Factors Design Handbook</u> . New York: McGraw-Hill, 1981. |

B. MILITARY PUBLICATIONS

Commanding Officer, U.S. Coast Guard Marine Safety Center, 400 Seventh Street SW, Washington, DC 20590-0001

| | |
|------------|---|
| NVIC 12-82 | Recommendations on Control of Excessive Noise |
|------------|---|

Commanding Officer, Naval Publications and Forms Center. 5801 Tabor Avenue, Philadelphia, PA 19120, 215-697-2667 or 2197.

AF DESIGN HANDBOOK 1-3 Human Factors Engineering (3rd ed., revision 2)

| | |
|------------------|--|
| AFR 161-35 | Hazardous Noise Exposure |
| BUMEDINST 6260.6 | Hearing Conservation Program |
| DOD-HDBK- 743 | Anthropometry of US Military Personnel |
| MIL-HDBK- 759 | Human Factors Engineering Design for Army Material |
| MIL-P-7788 | Panels, Information, Integrally Illuminated |
| MIL-STD-12 | Abbreviation for Use on Drawings, Specifications, Standards and in Technical Documents |
| MIL- STD- 129 | Marking for Shipment and Storage |
| MIL- STD-195 | Marking of Connections for Electric Assemblies |
| MIL-STD-415 | Test Provisions for Electronic Systems and Associated Equipment, Design Criteria for |
| MIL- STD - 454 | Standard General Requirements for Electronic Equipment |
| MIL-STD-490 | Specification Practices |
| MIL-STD-681 | Identification Coding and Application of Hookup and Lead Wire |
| MIL-STD-1247 | Markings, Functions and Hazard Designations of Hose and Pipe. |
| MIL-STD-1280 | Keyboard Arrangements |
| MIL- STD- 1348 | Knobs, Control, Selection of |
| MIL-STD-1472 * | Human Engineering Design Criteria for Military Systems, Equipment and Facilities |
| MIL-T-23991 | Training Devices, Military, General Specification |
| MIL-W- 5044 | Walkway Compound, Nonslip, and Walkway Matting, Nonslip |

C. FEDERAL PUBLICATIONS

| | |
|----------------|---|
| FED-STD-515/17 | Outside Rear View Mirror(s) for Automotive Vehicles |
| FED-STD-595 | Colors |
| 29 CFR 1910 | Occupational Safety and Health Standards |

D. ABBREVIATIONS USED IN THIS ENCLOSURE

| | |
|---------------|--|
| AFR 111-11 | Air Force Regulation 111-11 |
| BUMEDINST 111 | Bureau of Medicine and Surgery Instruction 111 |
| DIS | Draft International Standard |
| DOD-HDBK-111 | Department of Defense Handbook 111 |
| FED-STD-111 | Federal Standard 111 |
| MIL-HDBK-111 | Military Handbook 111 |
| MIL-STD- 111 | Military Standard 111 |
| NVIC | Navigation and Vessel Inspection Circular |

* USED EXTENSIVELY FOR LABEL AND TECHNICAL MANUAL DISCUSSIONS