

**PROPOSAL SUMMARY*****Friends of the Rail Bridge***

**Request Date:** 5/11/2018  
**Request Amount:** \$10,000.00

<b><u>Organization Name</u></b>	<b><u>Primary Contact</u></b>
Friends of the Rail Bridge 1015 E Bowen Avenue Bismarck, ND 58504 (701) 220-4513  <a href="http://friendsoftherailbridge.org">http://friendsoftherailbridge.org</a>  <u>Fiscal Sponsor Organization:</u> ND Community Foundation 711 Riverwood Drive, Suite 2 Bismarck ND 58504 45-0336015	Susan Wefald Volunteer  (701) 223-8975 susanwefald@msn.com

<b><u>Classifications</u></b>	
<b>Program Area Served:</b>	Civic and Community
<b>Support Type:</b>	Program Support
<b>Age Group:</b>	All Ages
<b>Gender:</b>	Males and Females
<b>Geographic Area Served:</b>	Region 7
<b>Ethnicity:</b>	Multi
<b>Program Area:</b>	Civic and Community
<b>Type of Support</b>	Program Support

**Project Information—Title, Project Start / End Dates, Description**

**Historic Missouri River Railroad Bridge Planning Sessions**  
**8/15/2018 -- 12/15/2018**

Burlington Northern Santa Fe (BNSF) Railroad is in the process of designing a plan to build a new railroad bridge at Bismarck-Mandan and abandon the historic bridge that has stood at this location since 1883. The United States Coast Guard (USCG) is the lead federal agency who will make a final

decision in this matter and they have invited comment from community groups known as “Consulting Parties.” Friends of the Rail Bridge (FORB), a grassroots organization that organized in April 2018, is a consulting party. Its mission statement is “FORB - Bridging community through history, education and recreation.”

FORB is seeking a community innovation grant to conduct four collaboration and joint planning sessions to explore creative and innovative ways the historic BNSF Railroad Bridge that spans the Missouri River at Bismarck-Mandan could be repurposed for the benefit of residents and visitors to central North Dakota. Over twenty-five local government, historical, and recreation organizations and Native American tribes and tribal historic preservation officers, are consulting parties (see attached list). These consulting parties will be invited to participate in four community innovation sessions to discuss important public interest issues concerning public safety, health, recreation, economic development and tourism relating to the existing historic Missouri River Railroad Bridge. The FORB group is open to unanticipated outcomes from the meetings.

Goal 1: In preparation for attending USCG sponsored meetings, provide opportunities for consulting parties to discuss and consider the needs of their communities related to a proposed new rail bridge and the threatened demolition of the existing rail bridge.

Goal 2: These sessions will increase collective understanding of the issues, enable the consulting parties to generate ideas and collaborate on possible solutions in preparation for upcoming USCG meetings related to the proposed new rail bridge and the existing rail bridge.

**Identify other sources of income, if any**

People will be donating extensive in-kind work to this project, through organizing, distilling information and ideas throughout this process.

**Provide a brief description of the community issue or problems you want to address**

BNSF Railway announced to the cities of Bismarck-Mandan in spring, 2017, that they planned to build a new rail bridge across the Missouri River. Immediately, community members posed the question “What will happen to the existing historic 1883 BNSF Railway bridge?” A young Bismarck teacher gathered 896 signatures in four days, supporting preservation of the historic bridge (“Seeds Planted to Preserve Bridge,” Bismarck Tribune, April 3, 2017, 1.). People in Bismarck and Mandan started talking about the possibility of converting the existing historic rail bridge to a recreation trail, as they learned about numerous successful “rail to trail” projects across the country.

The United States Coast Guard (USCG) is the lead federal agency who will make a final decision about the future of BNSF’s existing 1883 historic rail bridge (whether it will be destroyed or allowed to stand). Over 20 diverse community organizations have become official consulting parties in this case, including this organization (Friends of the Rail Bridge, FORB). Other consulting parties include units of city and county governments, local history organizations and recreation groups, Native American Tribes and tribal historic preservation officers (see list in "anything else of importance" section). As of this date, the USCG has held one public meeting on December 14, 2017 to explain the National Environmental Policy Act (NEPA) and Section 106 of the National Historic Preservation Act (Section 106) Process and take general comments. On January 31, 2018 the USCG invited consulting parties to a meeting. Another meeting is being held on May 14, 2018. The USCG has not published any schedule for

additional meetings but has promised to do so in the future. (e-mail to author, April 26, 2018). Along with addressing many other issues, government procedures expect consulting organizations to “discuss costs and how well your preferred alternatives would meet project needs.” (Pamphlet - Citizens Guide to Section 106 Review, Advisory Council on Historic Preservation, Washington, DC, 13)

At present, the consulting parties are separately preparing comments and trying to learn as much as they can about the USCG process to prepare for the USCG meetings. Little discussion is occurring between the government, community, and tribal entities to try to innovate and discover common interests and concerns. To facilitate public interest, prior to USCG meetings, it is imperative that community innovation meetings take place between the diverse consulting parties who share an interest in the BNSF Bridge. These meetings would promote enhanced discussion of community goals and/or issues, such as community health, safety, recreation, tourism, and economic development that relate to the BNSF rail bridge. These meetings need to take place independently of the USCG sponsored meetings, so that consulting parties are well prepared for the official meetings. This community innovation grant is needed to make these public interest and community innovation meetings a reality.

**Describe who will be involved in the process – Who are the key stakeholders?**

Susan Wefald, a volunteer with Friends of the Rail Bridge (FORB) will coordinate implementing the grant. Wefald, who previously served on the Bismarck School Board and on the ND Public Service Commission, will assist the facilitator (as a volunteer) when appropriate in the planned process. Jason Matthews, owner of JM Strategies, Bismarck, will be responsible for all four phases of the planned project. He may call on other people to assist him as needed. Participants: Over twenty Consulting Parties in USCG Case Proposed Bridge Replacement at Mile 1315.0 on the Missouri River near Bismarck/Mandan, North Dakota (See list under "anything else of importance" section). Each of these groups will be invited to send one to five people to the discussion sessions.

**Describe the steps involved in your problem solving process**

Note: The USCG may move quickly through its process of public and consulting party meetings, and therefore work must take place between August and December 2018.

Mid-August 2018: Friends of the Rail Bridge will hire a professional facilitator to plan and conduct four discussion sessions for consulting parties.

Early September 2018: Phase One – Organizing. The facilitator will schedule and arrange meeting sites for four, two-hour, discussion sessions for consulting parties. Since the discussions involve people from Bismarck, Mandan, and surrounding areas, three of the meetings will take place in Bismarck and one in Mandan. Incentives will be planned to obtain the desired attendance. A current list of consulting parties will be obtained with contact information.

Mid to late September 2018: Phase two – Preplanning. Each consulting party will be contacted through written communication and in small group meetings to share the purpose of the project and to plan the first general meeting. This phase may involve a preplanning survey. Some of these contacts may involve meetings over coffee or a meal, and therefore expenses are included in our grant request (\$1,000) to cover these important initial contacts. All the consulting parties will be invited to attend sessions one and four of the facilitated discussions. Sessions two and three will feature smaller group discussions, each session involving only one-half of the consulting parties.

October and November 2018: Phase three – Implementation. The four discussions will take place and will focus on important public interest issues including public safety, health, recreation, economic development and tourism related to a proposed new rail bridge and the historic rail bridge which is threatened with demolition. We will invite each consulting group to send one to five people to participate in the discussions. The first session will focus on increasing collective understanding of the issues. The smaller second and third group sessions will focus on brain storming and visioning. The fourth session will allow the collaborating parties to work together to develop possible solutions. Consulting parties will receive summaries of the ideas and possible solutions generated at the meetings.

December 2018: Phase four – Evaluation. Submit reports and evaluations of the process.

**Describe who will benefit from your project (populations, geography, etc)**

Citizens and visitors of Bismarck, Mandan, and central North Dakota; enrolled members of Native American Tribes; and citizens of the surrounding area will benefit from this project because it will promote community innovation discussions on public interest topics including health, safety, recreation, economic development, and tourism. FORB understands that unanticipated outcomes may result from this process. Bringing the consulting parties together to discuss public interest issues will generate far better ideas and strategies than one group could generate on its own. An important outcome will be shared ownership of the decision making as the collaborating parties pursue innovative ideas together.

**Describe how you will measure the success of your project**

Goal 1: In preparation for attending USCG sponsored meetings, provide opportunities for consulting parties to discuss and consider the needs of their communities related to a proposed new rail bridge and the threatened demolition of the existing rail bridge.

Measurement: By November 15, at least 75% of the Consulting Parties will attend three of the facilitated, two-hour discussions on public interest issues related to the proposed new rail bridge and the existing historic rail bridge which is threatened with demolition.

Goal 2: Community innovation sessions will increase collective understanding of the issues, enable the consulting parties to generate ideas and collaborate on possible solutions in preparation for upcoming USCG meetings related to the proposed new rail bridge and the existing rail bridge.

Measurement: At the fourth session, participants will rate each of the “possible solutions” using two methods. First method: Each possible solution will be rated on a scale of 1-5, with one as “unworkable” and five as “good chance of success.” Success will be a majority of the possible solutions scoring 4 or 5. Second Method: Each possible solution will also be rated as “meets no needs,” “meets our needs,” or “meets community needs.” Success will be a majority of the possible solutions scoring “meets community needs.”

**Describe how you plan to sustain the community innovation that results from your proposed process into the future**

Bringing these diverse groups together for discussion will be valuable for the future of our communities. Short term it will bring enhanced, thoughtful, planned discussion on the public interest to the USCG meetings on the BNSF Bridge. It may be years (or perhaps just months) before decisions are made on the existing historic BNSF Railway Bridge, but regardless of the final decision the USCG makes, it will start a constructive pattern of collaboration on important community issues. If the USCG allows more time for its decision-making process on the existing historic BNSF Railway bridge, that will allow the

collaborating parties time to continue to meet to test potential courses of action (solutions) before they are implemented.

**Does your project seek to actively reduce structural and/or systemic gaps in access, outcomes or treatment based on race/ethnicity or economic standing (no required)? If so, please describe**  
Native American Tribes and Tribal Historic Preservation Officers will be important participants in this project.

**Please add anything else of importance that we should know about you or your project**

Friends of the Rail Bridge (FORB) is a new organization, incorporated in North Dakota in April 2018. On April 3, 2018, a group of 67 people from Bismarck and Mandan gathered at a public meeting at the North Dakota Heritage Center to learn more about the existing historic (1883) railway bridge. At the meeting, they passed a resolution which stated, “Therefore, be it resolved, citizens who would like to see the historic BNSF railroad bridge left in place are forming a non-profit organization, Friends of the Rail Bridge (FORB), which is willing to take ownership of the bridge, with the goal of using the bridge as part of a recreational trail system between the cities of Bismarck and Mandan, ND. FORB intends to assume all liability, be responsible for inspection, maintenance, and discuss right of way issues with BNSF.”

An interim steering committee was established as we organized. Bylaws have been drafted, working groups established, and our original three directors have elected a new board of directors which will meet the end of May. As a new organization with no staff, if we receive this grant, we will contract out consultation and facilitation work necessary to make the project fair, balanced and achieve the goals. (See Section, “Who Will Be Involved in the Process?”). We understand, as the organization applying for this grant, that we are only one of many consulting parties in the USCG decision process. Our desire is to serve in the public interest of the Bismarck-Mandan Community. We don’t have preconceived expectations where this journey may lead us, and we understand their may be unanticipated outcomes. Our interest is to provide a forum for honest community discussion.

Since we are a new organization, we are seeking \$800 for director’s liability insurance as part of our administrative costs to ensure our board of directors is properly covered as we sign contracts involved in this grant. We are also seeking \$1000 to enable board members of FORB and/or members of their working groups to travel to visit with organizations managing other historic bridge preservation projects in our region, such as the Stone Arch Bridge in Minneapolis or the Fairview Lift Bridge across the Yellowstone near Fairview, ND/Mt. These visits would allow FORB to better prepare for the community discussions sponsored by this grant.

FORB is applying for this grant through the North Dakota Community Foundation, which is a 501c3 organization. Grant award checks should be made out to the North Dakota Community Foundation, which will charge us five percent of all funds disbursed for administration fees.

BNSF Bridge List of Section 106 Consulting Parties (additional organizations may choose to be consulting parties in the future)

Bismarck Historical Society

Bismarck-Mandan Historical and Genealogical Society

Bismarck Tour Company

Burleigh County – Burleigh County Building/Planning/Zoning  
City of Bismarck – Mayor’s Office  
City of Bismarck Community Development Department  
City of Mandan – Mayor’s Office  
Fort Abraham Lincoln Foundation  
Friends of the Rail Bridge  
Historic Bridge Foundation, Texas  
Lewis and Clark Riverboat  
Mandan, Hidatsa, and Arikara Nation and Tribal Historic Preservation Officer  
Mandan Historical Association  
Morton County Historical Society  
Morton County – Planning and Zoning and County Engineer  
North Dakota SHPO (State Historic Preservation Office)  
Preservation North Dakota  
Rails to Trails Conservancy National Headquarters  
Sisseton-Wahpeton Oyate and Tribal Historic Preservation Officer  
Spirit Lake Tribe of Fort Totten and Tribal Historic Preservation Officer  
Standing Rock Sioux Tribe and Tribal Historic Preservation Officer  
Turtle Mountain Band of Chippewa and Tribal Historic Preservation Officer  
United States Army Corps of Engineers  
Valerie Barbie

**North Dakota Community Foundation**

**Friends of the Rail Bridge**

**Historic Missouri River Railroad Bridge Planning Sessions**

	Year 1	Year 2	Notes
<b>SOURCES OF SUPPORT</b>			
Consensus Council/Bush Foundation	\$10,000	\$ -	
In-kind contributions	\$1,600		40 hours at \$40 an hour
Registration fees			
Other funding			
<b>TOTAL SOURCES OF SUPPORT</b>	<b>\$ 11,600</b>	<b>\$ -</b>	
<b>EXPENSES</b>			
Community Conversation Events	\$ -	\$ -	
Space Rental	\$1,000		Four Discussion Sessions
Facilitator(s)	\$4,700		Jason Mathews, project facilitator
Materials			
Marketing	\$1,000		Phase one preplanning meetings
Capacity Building / Training Events			
Space Rental			
Trainers and Training Cost			
Materials			
Marketing			
Coach/Mentor	\$1,600		In-kind donation
Operating Expenses / Overhead	\$1,000		Misc. Expenses
Staff Positions			
Rent			
Telephone/Internet			
Office Equipment & Supplies			
Printing & Postage			
Travel	\$1,000		Educational Travel
Other Expenses			
FORB Directors Insurance	\$800		Board of Directors Liability Ins.
NDCF Admin Expenses	\$500		5% of grant money
<b>TOTAL EXPENSES</b>	<b>\$ 11,600</b>	<b>\$ -</b>	



4585 Coleman Street  
Bismarck, ND 58503-0431  
701 355 8400  
[KLJENG.COM](http://KLJENG.COM)

October 29, 2018

Mark Zimmerman  
President  
Friends of the Railroad Bridge (FORB)  
Bismarck, ND

Re: Feasibility Study Scope of Services

Dear Mark:

Thank you for contacting us regarding the feasibility study for the potential repurposing of the BNSF Railroad Bridge over the Missouri River. One of the main factors in defining the level of effort for the study is related to the amount of information available for the existing bridge. In order for us to accurately scope the study, and provide meaningful study results, we request the following:

1. As-built plans for the existing bridge (both approach and main spans) including bearing details.
2. Permission to conduct a walking, track level inspection of the bridge by KLJ staff.
3. Recent inspection reports for the bridge, or correspondence related to the condition of the bridge. Essentially, what aspects of the bridge condition are driving the need to replace it?

Items 1 and 2 are mandatory to allow for a meaningful evaluation of the feasibility of converting the bridge to use as a trail crossing. If plans are not available and/or access is not granted, we will be unable to complete the study. Please forward this request as appropriate.

Sincerely,

**KLJ**

A handwritten signature in blue ink that reads "Wade Frank".

Wade Frank, PE  
Senior Bridge Engineer



# FRIENDS OF THE RAIL BRIDGE

BRIDGING COMMUNITY THROUGH HISTORY, EDUCATION, AND RECREATION

*At the time of its construction, the Bismarck-Mandan rail bridge over the Missouri was a technological marvel. Today, the bridge remains as one of the most important architectural landmarks of the Northern Plains region.*

*As the current bridge has been in service for over 100 years, Burlington Northern Santa Fe (BNSF) wishes to construct a new bridge to accommodate the demands of the modern era. However, their preferred plan includes eventual removal of the historic bridge.*

*Because of its historic significance, our community is legally afforded the chance to weigh in before a final decision is made. Friends of the Rail Bridge urges you to review this project proposal and engage in active participation to save this bridge and repurpose it for use as a community recreation resource.*

## 1. CONTACT INFORMATION

**Friends of the Rail Bridge**  
Mark Zimmerman, President  
1015 East Bowen Avenue Bismarck, ND 58504  
(701) 220-4513  
[friendsoftherailbridge@gmail.com](mailto:friendsoftherailbridge@gmail.com)  
[www.friendsoftherailbridge.org](http://www.friendsoftherailbridge.org)

## 2. PROJECT LOCATION

- The Bismarck-Mandan Rail Bridge spans the upper Missouri River. It has four piers. Its eastern pier lies in Bismarck. Its western pier is in Morton County. Two piers are in the water.
- The rail bridge is currently owned by Burlington Northern Santa Fe (BNSF).

## 3. PROJECT TYPE

- Signature Spaces
- All Ages and Wages
- Complete Connectivity



## 4. PROJECT TITLE AND DESCRIPTION

### Connecting Community Through Preserving and Repurposing Our Historic Rail Bridge

*By 2022, Friends of the Rail Bridge will find community partners and BNSF will agree to transfer the existing historic 1883 rail bridge to these community partners for a recreation trail. Plans will be in place to ensure that the existing historic bridge will connect to walking and biking trails.*

**BACKGROUND:** The historic 1883 rail bridge, owned by BNSF, is an iconic landmark for the community and state. Today, its image is ubiquitous, appearing in everything from corporate advertising to family portraits.

BNSF is currently in the process of updating their infrastructure, specifically older bridges across the country. The historic 1883 Bismarck-Mandan Rail Bridge is included in this group. Because the Missouri River is a navigable waterway, the US Coast Guard is the permitting agency.

BNSF has voiced that their preferred alternative for the project would be demolition of the existing bridge and construction of a new one in its place.

Because this bridge is historic and nationally significant—and the permitting agency is at the federal level—BNSF is legally required to undergo the 106 Process. This process seeks to give citizens a voice in the decision-making process before any final plans are made.

Friends of the Rail Bridge (FORB) seeks to find an alternative that satisfies all parties involved. FORB understands and respects BNSF’s need for a modern, dependable, more robust bridge. Our hope is to find an alternative that meets BNSF’s need for a new bridge while also respecting the community’s desire to maintain an iconic landmark. After all, Bismarck is a railroad town. It was originally named “Edwinton” in honor of a Northern Pacific railroad engineer. Our Bismarck-Mandan communities would not exist in their current form if not for the economic traffic enabled by the bridge.

Not only was the rail bridge significant to our city’s development—it was a transformational element in our nation’s history. The second transcontinental railroad was an audacious undertaking. It nearly bankrupted the country, triggering the Panic of 1873, and war on the Northern Plains. The bridge between Bismarck and Mandan was the linchpin in the railroad’s completion. A monumental engineering achievement, it holds profound historical significance in the American landscape. Symbolically, it remains a sobering reminder of our Nation’s contentious past and the effect of westward expansion on indigenous peoples.

The bridge is eligible to be on the National Register of Historic Places and has recently been selected by the National Trust for Historic Preservation to be on their list of “America’s Eleven Most Endangered Historic Places in 2019.”



## SCOPE OF WORK:

**May 2019:** National Trust for Historic Preservation lists the historic 1883 Missouri River rail bridge on “America’s Eleven Most Endangered Historic Places in 2019”.

**July 2019:** Feasibility Study is completed. The Northern Plains Heritage Foundation signed a contract in December 2018 with North Dakota State University’s Architecture and Landscape Architecture Department to perform a feasibility study on repurposing the existing Bismarck Missouri River Railroad Bridge to a pedestrian/bicycle facility.

**Summer 2019:** Bismarck City Commission chooses “Preserving and Repurposing” the bridge as one of the projects that are a part of their Strategic Plan.

**Summer - Fall 2019:** Resolutions of Support. The Bismarck City Commission and other community groups such as Bismarck State College and the State Historical Society of North Dakota send resolutions of support to preserve the bridge to the United States Coast Guard. The United States Coast Guard will soon be making a decision on whether the historic rail bridge will continue to exist after BNSF builds its new rail bridge.

**Fall - Winter 2019:** Friends of the Rail Bridge applies for and receives a grant from the Bush Foundation to (1) facilitate working relationships with community stakeholders and strategy partners and (2) to fund additional design, survey, and environmental work needed.

**Winter - Spring 2019-20:** Community Stakeholders and Strategy Partners, including Friends of the Rail Bridge (FORB), use information in the NDSU Feasibility Study and other community sources to develop funding plans to convert the bridge to a pedestrian/bicycle facility. Community Stakeholders explore funds from such sources as NDDOT, the federal government, and the ND Outdoor Heritage Fund.

**Summer 2020:** Preliminary Design and Topographical Survey is completed. Environmental documents are reviewed.

**Winter 2020 -Spring 2021:** Maintenance and Partnership Agreements are signed. Design and Construction documents are started.

**Summer 2021:** With community support and plans in place, BNSF makes plans to transfer the historic 1883 Missouri River rail bridge to a partnership of local public and private organizations, when its new bridge is built. The public organizations would take title for the bridge and the private organizations would be responsible for obtaining funds to convert the bridge to a pedestrian/bicycle recreation trail. Design and construction plans for the new bridge would be completed during this time.

**Fall 2021-22.** While the new BNSF Missouri River Rail Bridge is being built, BNSF and community stakeholders and strategy partners finalize plans for funding the conversion of the existing bridge to a pedestrian/bicycle trail. When new bridge is completed, BNSF transfers ownership of the existing bridge to the public-private partnership.

**BUDGET FOR PHASE 1:** \$65,000-\$75,000



## 5. COMMUNITY IMPROVEMENT STATEMENT

As cities grow, diversity, and age, they must seek new ways to support and engage the expanding community. Conversion of the historic bridge would not only engage citizens in a recreational sense, allowing yet another way to interact with the river, it would also engage citizens in a relation sense. Saving old structures in original locations allows interaction with the land as a learning tool—to understand what happened in the past and why. Saving the rail bridge would give citizens an opportunity to connect with each other through means of recreation, history, and education.

Preserving and repurposing the historic rail bridge into a bicycle and pedestrian pathway will satisfy the City's strategic focus areas of Signature Spaces, All Ages and Wages, and Complete Connectivity.

### Signature Spaces

With the exception of our state capitol, the bridge is the most iconic and distinctive structure in Bismarck.

*It is the signature space of our city.*

Preserving and repurposing the bridge is an opportunity to elevate an existing asset and provide opportunities for heritage tourism and riverfront enjoyment.

Once the bridge is repurposed, interpretive signage will focus on learning from history, discussing the hope and progress of our past while also considering its consequences on indigenous peoples. This place holds the power to bridge cultures, to connect past and present, to help shape a more just and humane future for generations to come.

Other communities have preserved bridges and used them as event venues and places of celebration. For example, the Stone Arch Bridge in Minneapolis is used as a venue for an annual art and music festival.

### All Ages and Wages

The Missouri River is Bismarck's greatest recreational asset. Because much of riverfront property in Bismarck is owned by private citizens, it is increasingly important for the City to optimize enjoyment of what is available to the public. The bridge's bicycle and pedestrian pathway will be integrated into Bismarck-Mandan's already robust trail system and will be free to use by the public. Furthermore, the bridge's proximity to BSC will provide even more green space to students, making Bismarck even more attractive as a college town.

### Complete Connectivity

This project will cultivate the healthy and sustainable activities of walking and biking by expanding and connecting the paved and off-road trail systems of Bismarck and Mandan.

The bridge's pedestrian pathway will connect with the Missouri Valley Millennium Legacy Trail which already provides a wealth of experience regarding recreation and cultural resources. The Millennium Trail's mission is to "preserve and enhance a precious part of our national heritage for future generations of Americans to treasure and enjoy." The rail bridge's pedestrian pathway fits perfectly within this mission and expands not only the physical path, but also adds depth to the story of the Northern Plains area.



## 6. COMMUNITY PROJECT

*The City of Bismarck has already identified the need of riverfront development. The bridge has the potential to be the focal point of riverfront activities and community gatherings for years to come. Beyond immediate benefits of trail connectivity and civic pride, economic impact and cultural sensitivity are long-term benefits that will blossom with time.*

### **How can the City of Bismarck support this project?**

1. Choose “Preserving and Repurposing” the bridge as a project included in Bismarck’s Strategic Plan.
2. Send a “Resolution of Support” to the United States Coast Guard in Summer 2019.
3. Facilitate partnerships between FORB and government entities. Preserving the historic rail bridge requires city and state partnerships. Friends of the Rail Bridge is able to do much of the administrative and coordination work to physically save the bridge, convert it, and maintain it. However, a partnership of government entities will need to serve as its sponsor.

## 7. PROJECT TIMELINE

*There are two phases to this project. The first phase has to be completed by 2022, or there will be no second phase. Phase One is a project in itself and merits being part of the City of Bismarck’s Strategic Plan.*

See “Scope of Work” in Section 4 for a complete timeline of the project.

**Date of Project Commencement:** Summer 2019

**Length of Time to Complete Phase One:** Summer 2022

**Phase Two:** Completion of the Entire Project. BNSF will first need to construct their new bridge before the conversion project on the old bridge can take place. BNSF will need 2-3 years to construct their bridge. A conversion project would take a similar time-frame. Project completion would be roughly 6-8 years from the start of the project. Assuming construction of the new BNSF bridge starts next year, completion of the old bridge conversion would be 2026.

## 8. RESPONSIBLE PARTIES

Several successful models for bridge conversion projects such as this exist. Following the Fairview-bridge model (located in our own state of North Dakota), a non-profit (FORB) takes direct ownership and asks the city and state for support in helping form partnerships for maintenance.

Following the Stone Arch Bridge Model (located in Minneapolis, MN), a government partnership takes ownership and the bridge is operated by a public-private partnership. In this model, we ask the City of Bismarck to help facilitate conversations and form partnerships.

Regardless of which model is used, Friends of the Rail Bridge has the ability to be involved in the bridge conversion and maintenance for the duration of the bridge’s lifetime.



## 9. PROJECT SUSTAINABILITY

Throughout the past year, the members of the FORB Board of Directors have demonstrated through their actions and fiscal responsibility that they have the ability to be responsible for the long-term implementation of this proposed project. In the next two years, FORB will be filing the paperwork to become a 501(c)(3) organization.

Friends of the Rail Bridge (FORB) is a non-profit organization, registered with the State of North Dakota. The corporation is organized exclusively for the charitable and educational purposes within the meaning of 501(c)(3) of the Internal Revenue Service Code, and more specifically including the preservation and adaptive re-purposing of the historic Railroad Bridge across the Missouri River between the cities of Bismarck and Mandan, North Dakota, as a recreational and educational part of the area's trail and park system.

Founded in May 2018, the Mission of FORB is "Bridging Community Through History, Education, and Recreation." At the present time, the North Dakota Community Foundation is our fiscal sponsor. FORB applied for and received a \$10,000 Community Innovation Grant from the Bush Foundation in Summer 2018, and successfully implemented that grant through March 2019. One idea that evolved through "community innovation meetings" funded through the Bush Foundation Grant, was that a feasibility study be conducted, to answer questions about conversion costs and other issues related to converting the bridge to a recreation facility. FORB decided to enlist the help of a community partner, Northern Plains Heritage Foundation, which arranged funding and signed a contract for a feasibility study with the Architecture and Landscape Architecture Department at North Dakota State University. FORB recruited government and private entities, including the City of Bismarck, to be members of a Steering Committee for the Feasibility Study.

Preserving the historic rail bridge requires city and state partnerships. Friends of the Rail Bridge is able to do much of the administrative and coordination work to physically save the bridge, convert it, and maintain it. However, a government entity will need to serve as its owner to sustain the project for the long term.

## 10. ANTICIPATED COMMUNITY BENEFITS

*"In the end, our society will be defined not only by what we create  
but by what we refuse to destroy." -John Sawhill*

The above quote was spoken by John Sawhill. He was CEO of the Nature Conservancy for decade and he was onto something that applies to nature, open spaces, and historic spaces. We can take Bismarck—which is a good city—and systematically make choices that turn it into a great city. The rail bridge is one of those choices.

Repurposing the rail bridge will accomplish several of the City of Bismarck's goals for long-term planning of the city's success. It will promote:

- Riverfront development
- Outdoor recreation and interconnectedness of paved and off-road trail systems
- Interactive learning through interpretive signs and proximity to other historic sites/trails/buildings
- Increasing amenities to college students
- Heritage tourism
- Enhanced community pride

The 1883 historic Missouri River rail Bridge is an iconic symbol of Bismarck. It is the same age as the Brooklyn Bridge in Manhattan, and is a special part of our "sense of place." Although it is already one of our historic treasures, it can also become a part of the daily life of our citizens as they bike or walk across the bridge, enjoying river views of our great city.



## 11. MAXIMIZE AND UTILIZE EXISTING RESOURCES

The City of Bismarck's Call for Projects comes at an opportune time in the life of the Bismarck-Mandan Rail Bridge. Although this bridge has shaped our community's past, it remains to be seen in what way it will shape our future.

All of the potential described in this document—incorporating history, education, and recreation—will be lost if the bridge is demolished. A landmark will be gone, erased from the landscape. Friends of the Rail Bridge believes that repurposing the bridge is not only feasible—but vital to the success of a balanced Bismarck-Mandan community.

## 12. SUPPLEMENTAL INFORMATION

*The feasibility study done by North Dakota State University's Architecture and Landscape Architecture Department will be completed July 2019. Should you have interest, please contact us at that time for a finalized copy. A few pages of the 95% draft have been included for your reference. Of particular importance is section 4.5, which is a "Summary of Findings and Opinion of Feasibility".*

FOR IMMEDIATE RELEASE  
From: Friends of the Rail Bridge

## **RAIL BRIDGE NAMED TO 11 MOST ENDANGERED LIST**

**Bismarck, North Dakota - May 30, 2019** Friends of the Rail Bridge and the National Trust for Historic Preservation join to announce the Bismarck – Mandan Rail Bridge has been named to America’s 11 Most Endangered Historic Places.

“It is with both great excitement and deep concern that I announce today the Bismarck – Mandan Rail Bridge has been named by the National Trust for Historic Preservation to its 2019 list of America’s 11 Most Endangered Historic Places,” said Amy Sakariassen, North Dakota Advisor for the National Trust Historic Preservation. “Make no mistake, the historic 1883 rail bridge—a local icon and American landmark—is in dire threat of destruction.”

The historic 1883 rail bridge, owned by BNSF Railway, is an iconic landmark for the community and state. Its image is ubiquitous, appearing in everything from corporate advertising to family portraits.

It was the first bridge to cross the upper Missouri. George Shattuck Morison designed and oversaw its construction between 1880 and 1883. The project employed advanced construction methods, including pneumatic caissons such as those used to build its contemporary, the Brooklyn Bridge. Arguably, it is the most historically significant structure on the Northern Plains.

"As a Bismarck-Mandan native, I am delighted to support the local and national efforts to preserve our old railroad bridge," said Jay Clemens, Vice Chair of the Board of Trustees for the National Trust. "Few structures embody so many of the complex historical themes associated with the opening of the Upper Missouri region to settlement – opportunity for immigrants, the corresponding dislocation and subjugation of native peoples, the economic and political power of the railroads, the resulting rise of prairie populism, and the strains and opportunities associated with an increasingly smaller world and faster access to information and commodities. Many of these themes challenge us as much today as they did when the bridge was built."

Claudia Berg, Director of the State Historical Society of North Dakota, spoke about heritage tourism and the many opportunities the bridge could bring to the state’s third leading industry. “In an age of all most everything being disposable, our grandparents and great grandparents who lived through the Depression and our children today recognize the value of recycling or repurposing what we have. This bridge should not be thought of as disposable,” said Claudia Berg. According to the National Trust, heritage tourism encourages travelers to experience the places, artifacts and activities that authentically represent the stories and people of the past. These stories and places underpin our local identities and create positive economic and social impact.

Friends of the Rail Bridge (FORB) has been advocating for a preservation alternative to the proposed demolition of the 1883 Bismarck-Mandan Rail Bridge. FORB received two grants in 2018—a Community Innovation Grant to explore public-private partnerships and another to complete a feasibility study that is helping to facilitate planning and consultation in negotiations with the U.S. Coast Guard, BNSF and other state and federal agencies under Section 106 of the National Historic Preservation Act.

“Bridging our past to the future is a real possibility,” said FORB President, Mark Zimmerman. “Success stories can be found all across our country of communities that shared a vision and commitment to do something bold. Just as George Morison seized the opportunity to design and build this wonderful

structure, we have the opportunity to save this bridge for all of us and for future generations to enjoy and learn of our past and dream of our future.”

The National Trust for Historic Preservation has been protecting America’s historic buildings, landscapes and neighborhoods for more than 60 years. Places like Antietam National Battlefield, Jamestown, Virginia, George Washington’s Mount Vernon, and Theodore Roosevelt’s Elkhorn Ranch have been threatened by neglect, insufficient funds, inappropriate development or insensitive public policy.

**The other recipients on the 2019 list of America's 11 Most Endangered Historic Places (in alphabetical order):**

**Ancestral Places of Southeast Utah**  
**The Excelsior Club. Charlotte, North Carolina**  
**Hacienda Los Torres. Lares, Puerto Rico**  
**Industrial Trust Company Building. Providence, Rhode Island**  
**James R. Thompson Center. Chicago, Illinois**  
**Mount Vernon Arsenal and Searcy Hospital. Mount Vernon, Alabama**  
**Nashville’s Music Row. Nashville, Tennessee**  
**National Mall Tidal Basin. Washington, D.C.**  
**Tenth Street Historic District. Dallas, Texas**  
**Willert Park Courts. Buffalo, New York**

**About the National Trust for Historic Preservation**

The National Trust for Historic Preservation, a privately funded nonprofit organization, works to save America’s historic places. The Trust’s mission is to protect significant places representing our diverse cultural experience by taking direct action and inspiring broad public support, fostering a deep sense of community, commitment, and passion for saving places.

<https://savingplaces.org>

**Friends of the Rail Bridge (FORB)**

(FORB) is a non-profit organization dedicated to the preservation and repurposing the 1883 railroad bridge that spans the Missouri River between Bismarck and Mandan. The Mission of FORB is “Bridging Community Through History, Education, and Recreation.”

<https://www.friendsoftherailbridge.org>

Tell the Coast Guard to Save This Place, go to this link to sign a petition:

<https://savingplac.es/2QuHzn4>

**Media Contact:**

Margie Zalk Enerson

701-400-1028

[margie@engage2inspire.com](mailto:margie@engage2inspire.com)

A video of the official announcement can be found here:

[https://youtu.be/8cVB-0mJ\\_EQ](https://youtu.be/8cVB-0mJ_EQ)

Feasibility Study Steering Committee on  
Repurposing the BNSF Bismarck Missouri River Railroad Bridge  
As a Pedestrian/Bicycle Facility  
December 2018

Jason Tomanek  
Assistant City Administrator, City of Bismarck  
[jtomanek@bismarcknd.gov](mailto:jtomanek@bismarcknd.gov)

Dannette Welsh  
Clerk of Captains Landing  
[dodenbac@gmail.com](mailto:dodenbac@gmail.com)

Dave Mayer  
Bismarck Parks and Recreation  
[dmayer@bisparks.org](mailto:dmayer@bisparks.org)

Jesse Hanson  
ND State Parks and Recreation  
[jehanson@nd.gov](mailto:jehanson@nd.gov)

Fern Swenson  
State Historical Society of ND  
[fswenson@nd.gov](mailto:fswenson@nd.gov)

Mark Zimmerman  
Friends of the Rail Bridge  
[markzimmerman38@outlook.com](mailto:markzimmerman38@outlook.com)

Aaron Barth  
Northern Plains Heritage Foundation  
[aaron.l.barth@gmail.com](mailto:aaron.l.barth@gmail.com) or [aaron@northernplainsheritage.org](mailto:aaron@northernplainsheritage.org)

Tim Nilsen  
Director, Morton County Parks  
[tim.nilsen@mortonnd.org](mailto:tim.nilsen@mortonnd.org) 701-667-3363

Tony Geurholtz  
Morton County Parks Board  
[tjwillow@midco.net](mailto:tjwillow@midco.net)

Steve Saunders  
Bismarck Mandan Metropolitan Planning Organization  
[ssaunders@bismarcknd.gov](mailto:ssaunders@bismarcknd.gov)

Mike Herzog  
BNSF  
[Mike.Herzog@BNSF.com](mailto:Mike.Herzog@BNSF.com)

## Proposed Schedule for Feasibility Study

- Review project scope and understanding/FORB committee call Dec. 2018
- Site visit and review of early findings Jan. 2018
- Cost Estimate complete Jan. 2019
- Summary of Findings and Opinion of Feasibility Feb. 2019
- Review of feedback collected May 2019
- Final conclusion and report July 2019

## Scope of Work:

The purpose of this study is to determine the feasibility, cost estimates and conceptual improvements necessary to repurpose the existing BNSF Bismarck Missouri River Railroad Bridge as a pedestrian/bicycle facility. Questions the NDSU team will work to answer and report on:

1. Is it feasible to repurpose the existing bridge with a new bridge in place thirty feet to the north or alternately, eighty feet to the north?
  - a. Regarding the history of similar efforts with the Fairview Lift Bridge
    - i. How was ownership transfer accomplished?
    - ii. Challenges and issues?
  - b. Governance and liability issues:
    - i. Adjacent active rail line and BNSF issues
    - ii. Other agency/jurisdiction issues (including ND DOT, ND State Parks, Bismarck Parks and Recreation District, Morton County Parks, Captains Landing Township, City of Bismarck) iii. Liability/Insurance issues
  - c. Cost estimates, including recommended funding sources, phases and timing:
    - i. Converting the bridge deck to a pedestrian/bicycle walkway
    - ii. Conceptual alignments and R/W needs for connecting trails:
      1. Connecting the bridge to the existing paved ped/bike trail along River Road on the east side of the river. Include alternatives to phase the improvements, such as an at-grade crossing of River Road vs. a grade separated crossing of River Road.
      2. Connecting the bridge to the existing nature trail north of the existing bridge on the west side of the river.
      3. Connecting the bridge to the existing trail system and future expansion of trail system in Morton County
      4. Identify potential natural area mitigation land to offset potential R/W impacts to the designated natural area northwest of the existing bridge.
      5. Consider connections to other existing or future trails. iii. Railroad security, maintenance, pedestrian safety and R/W access:
        1. Identify proposed improvements to address the security, safety of pedestrians and liability issues of a ped/bike facility on and along existing active railroad

R/W, including the location of any access required by BNSF to maintain their proposed new bridge.

2. Cost for easement across BNSF property iv.

Estimated annual and periodic maintenance costs.

d. Analysis of bridge condition for conversion to pedestrian walkway.

i. Structural analysis will be cited from earlier BNSF study or completed by others.

e. Action plan and implementation schedule that would be required to accommodate repurposing the bridge, including

i. Agency and Jurisdictional Coordination

ii. Potential sponsors/governance

iii. Funding

iv. Public input

2. Summary of Findings and Opinion of Feasibility.



# BISMARCK MISSOURI RIVER BRIDGE

## Historic Bridge Repurposing Feasibility Study



National Trust for Historic Preservation  
**America's 11 Most  
Endangered Historic Places**

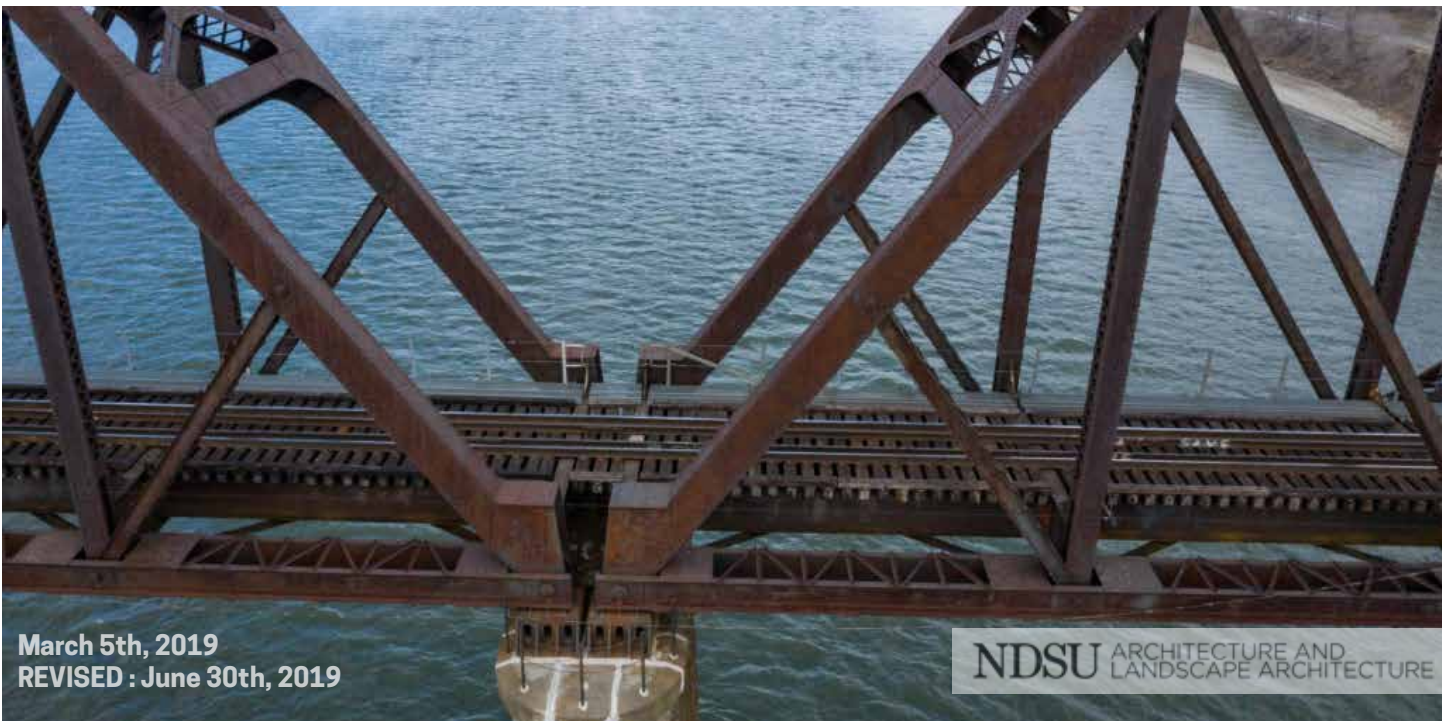

March 5th, 2019  
REVISED : June 30th, 2019

**NDSU** ARCHITECTURE AND  
LANDSCAPE ARCHITECTURE

# TABLE OF CONTENTS



## SECTION 1 Executive Summary

1.1 Project Overview & Scope	8
1.2 Project Location	10
1.3 History of Similar Efforts	11
1.4 Project Data	15

## SECTION 2 Existing Conditions

2.1 Governance & Liability Issues	18
2.2 Agency & Jurisdiction Issues	19
2.3 Bismarck/Mandan, Morton County Trail Connections	20
2.4 Railroad Security, Maintenance & Pedestrian Safety Improvements	21

## SECTION 3 Opinion of Probable Construction & Maintenance Cost

3.1 Opinion of Probable Costs for Constructure & Maintenance	27
3.2 Conceptual Alignments & ROW Needs for Connecting Trails	28
3.3 Connections to Existing Morton County Trails	30
3.4 Connecting to a Future Expansion of a Cultural Trail System	31

## SECTION 4 Action Plan and Schedule

4.1 Project Schedule and Timeline	34
4.2 Potential Sponsors/Governance	35
4.3 Funding	36
4.4 Public Input	37
4.5 Summary of Findings & Opinion of Feasibility	38
4.6 Disclaimer	40

## APPENDICES

A. Location Map	43
B. Site Photos	44
C. Preliminary Site Plans	50
D. Steering Review Committee Input	52
E. Pre-Design Cost Opinion Details	56
F. National Trust for Historic Preservation: Bismarck-Mandan Rail Bridge 11 Most Endangered Places 2019.	58
G. BNSF - Prior Studies and Diagrams	64
H. Community Input	66
I. Public Notice D8 DWB-887 Similar Historic and Companion Bridge Project between BNSF & U.S. Coast Guard from April 2019 across the Missouri River in the State of Missouri.	68

# Acknowledgments

Bismarck Missouri River Railroad Bridge  
Historic Bridge Repurposing Feasibility Study

Prepared for:

“The Bismarck Missouri River Railroad Bridge Steering Committee”

Prepared by:

North Dakota State University, Landscape Architecture



Acknowledgments:

The Bismarck Missouri River Railroad Bridge Steering Committee

Jason Tomanek  
Assistant City Administrator, City of Bismarck

Dannette Welsh  
Clerk of Captains Landing

Dave Mayer  
Bismarck Parks and Recreation

Jesse Hanson  
ND State Parks and Recreation

Fern Swenson  
State Historical Society of ND

Mark Zimmerman  
Friends of the Rail Bridge

Aaron Barth  
Northern Plains Heritage Foundation

Tim Nilsen  
Director, Morton County Parks

Tony Geurholtz  
Morton County Parks Board

Steve Saunders  
Bismarck Mandan Metropolitan Planning Organization

Mike Herzog  
BNSF

# 01

**EXECUTIVE SUMMARY**

## SECTION 1 Executive Summary

### 1.1 Project Overview & Scope

North Dakota State University's Department of Architecture and Landscape Architecture, in collaboration with a steering committee local to the project area, is completing a study to consider whether it is feasible to repurpose the existing historic Northern Pacific Railroad bridge into a pedestrian and bicycle path with BNSF's proposed new bridge in place thirty feet to the north or, alternately, eighty feet to the north. An NDSU 4k drone inspection of the bridge occurred on December 21, 2018, with Federal Aviation Administration-approved



figure 1.0] aerial drone view of high bridge

pilot Dr. Meghan Kirkwood. Photos from this drone inspection informed the feasibility meetings. The first feasibility kickoff meeting was on January 11, 2019, Friday, from 11:30AM to 1:00PM (CST), held at Bismarck State College's National Energy Center of Excellence (NECE) Conference Room #335, 1500 Edwards Avenue, Bismarck, North Dakota.

The second feasibility meeting date was coordinated in conjunction with the understandably busy schedule of the BNSF Director of Bridge Construction. This meeting was initially scheduled for the end of

January, but was rescheduled so Mr. Herzog could attend on February 19, 2019, Tuesday, 11:30AM to 1:00PM (CST), and held at the Bismarck-Mandan Chamber of Commerce meeting room, 1640 Burnt Boat Drive, Bismarck, North Dakota. For those unable to physically attend the first or second meeting, NDSU made available the ability to call into the meetings and follow along with the Power Point slides via "Zoom."

In addition to considering repurposing the historic bridge, this feasibility study considers how a repurposed bridge would connect with the existing public trail systems on the east and west side of the Missouri River.

The historic bridge is recommended eligible for the National Register of Historic Places according to criteria A, B and C. It is our understanding that "a new railroad bridge is proposed 30' or 80' north of the existing bridge" and the conversion of the existing bridge to a pedestrian facility has been discussed during consulting party meetings with the United State Coast Guard (USCG) for the Federal law that are the Section 106 processes.

The project area, as noted in the Class II Cultural Resource Inventory, lies within one mile of 49 previously recorded cultural resources, and in alignment with the city centers of Bismarck and Mandan, ND.

This report presents the results of this study. Included in the study are governance and jurisdiction considerations, security and maintenance issues, and a discussion and opinion of probable costs to complete and maintain the project. Beyond the 1880s historic BNSF steel bridge structure, the study considers connections to established and heavily used trails and road connections and considerations for expanded and future trail connections.



[figure 1.1] aerial drone view of high bridge

Environmental impacts, project costs, permitting, accessibility and preliminary design location and materials are also evaluated in this study.

## 1.2 Project Location

The project area is approximately 60 acres and includes BNSF right-of-way parcels, private parcels, City of Bismarck property and NDDOT property.

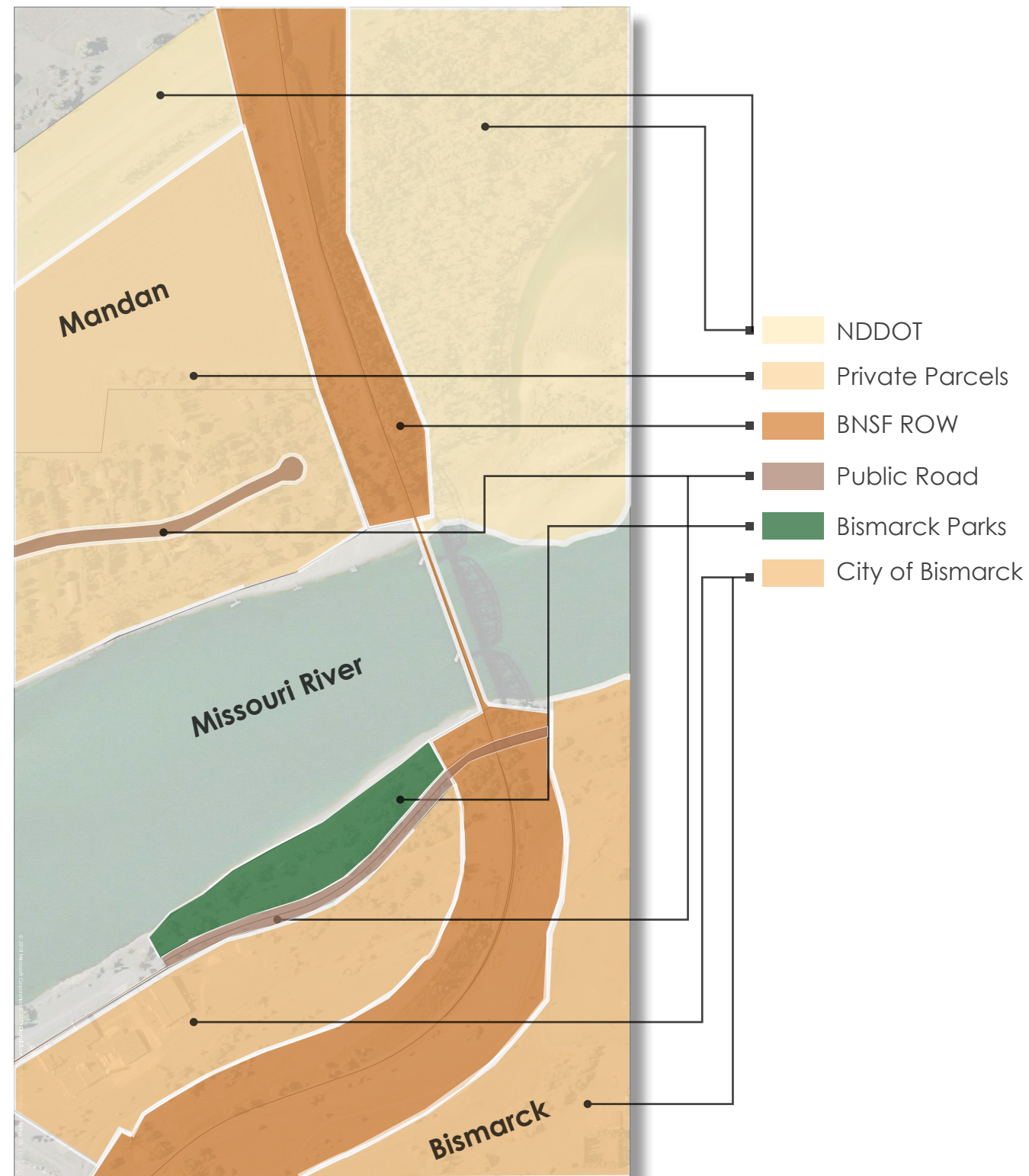

## 1.3 History of Similar Efforts

A cursory sample of successful efforts to repurpose historic bridges to pedestrian and bicycle trails is expansive and extends throughout all of the United States. The Rails-to-Trails Conservancy and the Historic Bridge Foundation have non-exhaustive lists of successful historic bridge preservation, restoration, and repurposing projects. Two case studies that inform this feasibility study include the Fairview Lift Bridge near Cartwright, North Dakota and the Stone Arch Bridge in Minneapolis, Minnesota. Also mentioned below is the Programmatic Agreement used to rehabilitate the historic Sorlie Bridge that spans the Red River of the North from East Grand Forks, Minnesota to Grand Forks, North Dakota.

### Fairview Lift Bridge

The Fairview Lift Bridge constructed by Gerrick & Gerrick stretches 1,320 feet across the Yellowstone River. In its earlier days, the Fairview Lift Bridge not only accommodated rail traffic, but also vehicular traffic. Planking was placed between and outside the rails to accommodate automobiles. It was converted to a walking bridge in 2001. A summary of the history, largely given from the transcript of the Section 106 meeting number 8 on October 10th, 2018, 2:48 pm ET follows.

Ray Trumpower, Friends of the Fairview Bridge, "what we did was we talked to a 16-county economic development group in Eastern Montana and said, "Would you do this deal for us? And then when we get our 501(c)(3), you can then pass the property to us." Eastern Plains RC&D transferred ownership to the Friends of the Fairview Bridge. They also built an ADA accessible parking lot, using the IS-TEA program, the Intermodal Surface Transportation Efficiency Act funding. Under ISTEA, Transportation Enhancement Program funds could be used for the construction of pedestrian and bicycle facilities, such as pedestrian bridges with all modes of transportation working together efficiently."



[figure 3.0] State Historical Society of North Dakota, William E. (Bill) Shemorry Photograph Collection (1-75B-4-11)

The dual-purpose bridge was not an active rail line at the time of the purchase and conversion. The local group added a walkway and handrails for safety. Liability, since it is a publicly accessible site, is covered by the North Dakota Century Code, the same legislation that provides blanket coverage for public sites and outdoor recreation sites. BNSF also made a financial donation to the local nonprofit to assist the project. Mr. Trumpower noted that the interest gained on the account has allowed it to increase to approximately \$250,000. According to Kris Swanson of BNSF, the quit claim deed was signed in December 2001, along with a monetary transfer of \$150,000 from BNSF to Friends of the Fairview



[figure 4.1 & 4.2] views of fairview lift bridge  
mckenzie county, north dakota

### Sorlie Bridge

The Sorlie Bridge between Minnesota and North Dakota in Grand Forks utilized a Program Agreement (P.A.) that was handled under the Minnesota's historic bridge management plan. The state of North Dakota may also look to developing a statewide P.A.



[figure 5.0] sorlie bridge at night  
grand forks, north dakota

### Old Cedar Avenue Bridge

On February 21, 2019, Erin Hanafin Berg, Policy Director from Preservation Alliance of Minnesota, e-mailed the local Friends of the Rail Bridge non-profit group. Berg provided a link to another completed bridge project, this one automotive, the Old Cedar Avenue Bridge: <https://www.bloomingtonmn.gov/eng/old-cedar-avenue-area-project>

Berg said:

"This project was a long time in the making, and was not without its local detractors and skeptics. Ultimately, a determination by the involved Federal agencies (US Fish and Wildlife, FHWA/FTA, and/or US Army Corps of Engineers) that the Old Cedar Avenue Bridge could be successfully rehabilitated cleared the way for other essential partners to get on board. Let me know if you'd like more detailed information than the city's website provides and I can put you in touch with other people who were involved in the project."

Following up with individuals within Federal agencies regarding this project could also be advantageous, and inform the compliance issues required through the United States Code of Federal Regulations.

### Stone Arch Bridge

The Stone Arch bridge in Minneapolis, is a contemporary of the historic Northern Pacific Railroad Bridge. The Stone Arch bridge was purchased by the Minnesota Department of Transportation in the 1990s and is currently maintained by the Minneapolis Park District.



[figure 6.2 & 6.3] stone arch bridge  
minneapolis, minnesota

## Rails-With-Trails Examples

Although the successful examples listed above utilize corridors without active rail assets, there are over 350 completed project examples from over 41 states where rail-with-trail developments have satisfactorily addressed any concerns about risk and liability. A few photo examples are shown below.



The full list can be found at [https://www.railstotrails.org/resourcehandler.ashx?name=americas-rails-with-trails-rail-with-trail-list&id=16685&fileName=Rail-with-TrailList%20spreadsheet\\_UPDATED%202019.01.11.pdf](https://www.railstotrails.org/resourcehandler.ashx?name=americas-rails-with-trails-rail-with-trail-list&id=16685&fileName=Rail-with-TrailList%20spreadsheet_UPDATED%202019.01.11.pdf)



## 1.4 Project Data

### Summarized Costs

Maintenance Costs : **\$63,500 annualized**

### Estimated Construction Costs :

Superstructure	\$150,000.00
Substructure	\$285,500.00
Railing & Fencing	\$457,600.00
Decking & Paths	\$926,000.00
Earthwork	\$3,150,000.00
Electrical	\$80,000.00
Inspection	\$94,000.00
Design + Management Serv.	\$600,000
Contingencies	\$1,148,620
<b>Total</b>	<b>\$6,891,720.00*</b>

\*For itemized activity listing and costs, see Appendix E

Estimated Construction Duration : 14 months

#### ROW Involvement :

Partial Property Acquisition or easement permit for City of Bismarck property on the east connection to the bridge and acquisition or permitted use of BNSF ROW (approximately 2 acres)

#### Possible Permits :

- Local Planning & Zoning Approval
- ACOE - Section 404 Permit
- Flood Management Certification

02

**EXISTING CONDITIONS**

## 2.1 Governance & Liability Issues

Governance and liability of repurposed railroad bridges or rehabilitated automotive bridges in North Dakota have several precedents from which to follow, including, the Fairview Lift Bridge in Cartwright, North Dakota, and the Sorlie Bridge that spans the Red River between East Grand Forks, Minnesota and Grand Forks, North Dakota.

### Liability Issues :

The city, county, state, Federal and non-profit complex of heritage recreation resources along the Missouri River in central North Dakota is expansive and vast. It is a reflection of the interests of the residents and visitors to the area. The everyday lives of most North Dakota residents includes some form of outdoor recreation, from hiking and biking to snowshoeing and snowmobiling.

The North Dakota Century Code (NDCC) Chapter 53-08 provides liability reassurance for public and private lands leased or used for public recreation. As summarized by the North Dakota Parks & Recreation Department, 53-08 "protects landowners and local government by limiting the liability they may incur from public recreation on their property." Furthermore, "a landowner is not specifically required to keep the premises safe for recreational purposes regardless of the location and nature of the recreational activity and whether the entry (authorized or unauthorized) or use by others is for their own recreational purposes or is directly related to the recreational activity of other person. Landowners are also not required to warn users of dangerous condition, use structure or active on the property...Unless otherwise agreed in writing, owners leasing land to the state or political subdivisions for recreation are not required to keep the property safe for others or warn users of any hazardous conditions, uses, structures or activities."

Because the preservation of the bridge and access points are currently BNSF Right of Way, any entity that would own the bridge would consider and formulate a way in which the ownership of the bridge could be placed in the public domain so that it would be covered by NDCC Chapter 53-08.

The vast majority of the over 350 rails-with-trails projects are insured by an existing local umbrella policy, similar to most rail-trails and greenways. According to the Rails-to-Trails Conservancy, "the increasing adoption of rails-with-trails has the potential to further reduce collisions by providing safe and intentional alternative to trespassing on tracks. Americans increasingly demand that they be given balanced transportation options that include safe and healthy places to walk and ride. Taking full advantage of corridors to facilitate both rail and active transportation."

## 2.2 Agency & Jurisdiction Issues

There are several agency and jurisdictional options for the Friends of the Rail Bridge (FORB) to move forward with a successful partnership with local and state entities. Following the Fairview Lift Bridge model between Montana and North Dakota, the Friends of the Rail Bridge could have ownership transferred either from BNSF directly, along with a monetary gift and potential 501c3 tax deduction. There are several commercial appraisers in the region, whose services would be needed to maximize this opportunity for both parties. Operations and maintenance of the bridge could be implemented by Bismarck Parks and Recreation and Morton County Parks or by the Friends of the Rail Bridge.

A second option, would be to follow the Stone Arch bridge model and have the BNSF Missouri River Railroad Bridge purchased by the North Dakota State Department of Transportation and maintained and operated by partnerships between Bismarck, Mandan, and Morton County Parks and the Friends of the Rail Bridge.

A third option would be to have a public agency, such as NDDOT or ND State Parks, actually own the historic bridge, and have an agreement in place where the non-profit such as Friends of the Rail Bridge raises funds toward an endowment, the interest of which would go toward maintaining the historic bridge.

## 2.3 Bismarck/Mandan, Morton County Trail Connections

The City of Bismarck Parks and Recreation District and the Morton County Parks District are both highlighted by excellent and abundant access to trails. They both have a dedication to innovative partnerships and involvement with the community and region. Bismarck State College, with approximately 3,800 students, the 3rd most populous student body within the 11 public universities in North Dakota, is immediately adjacent to the proposed historic 1883 rail bridge recreation trail." There is strong opportunity for connecting the rail bridge recreation trail to the Bismarck State College Campus, and further to the State Capitol Grounds, Downtown District, city and county trails in Morton and Burleigh County, Fort Abraham Lincoln State Park, and more broadly it would provide the only dedicated pedestrian and bicycle trail to span the Missouri River in central North Dakota

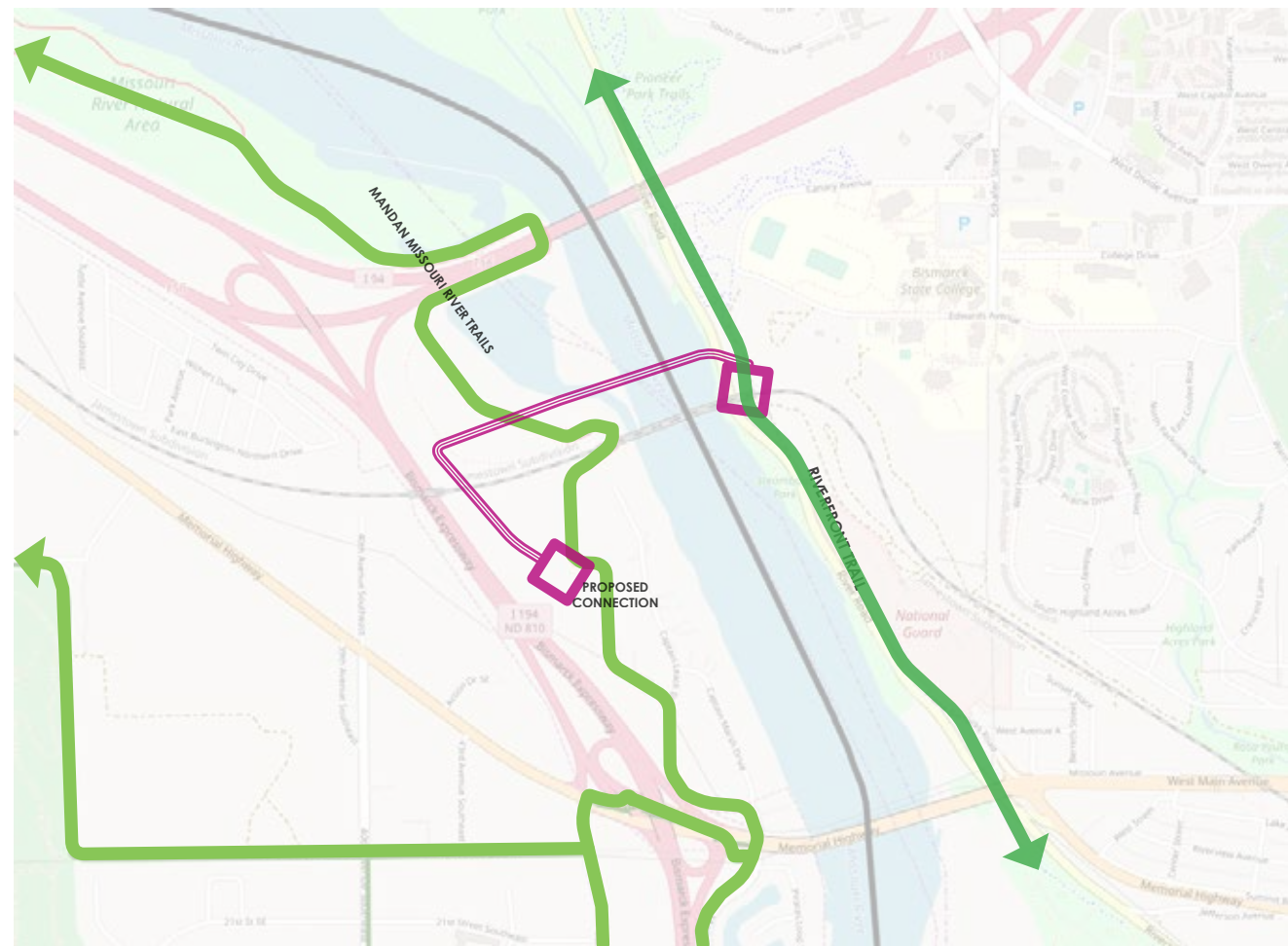

**existing trails**

**proposed trails**

[figure 8.0] Bismarck/Mandan and Morton County Trails as obtained from the G.I.S. databases of the City of Bismarck and Morton County (a portion of the Captain's Landing trail has been recently closed)

## 2.4 Railroad Security, Maintenance & Pedestrian Safety Improvements

The most recent Railroad Bridge Inspection Report, conducted on May 30th, 2018, confirmed the bridge in service has the capacity to safely carry traffic being operated over the bridge. The bridge is currently slated to be actively used by heavy rail traffic until 2022 or later.

As highlighted by the December 2017, Bismarck – Mandan Bicycle and Pedestrian Plan completed by Stantec, Bartlett and West and the University of Minnesota for the Bismarck Mandan Metropolitan Planning Organization. The plan calls for "several improvements to connect the downtown to the wider bicycle and pedestrian network, including a rails-with-trails connection to the riverfront trails along the south side of the existing railroad track....and utilizing the historic rail bridge."

Repurposing the bridge for bicycles and pedestrians would require a separate, secure, and safe access ramp. These estimates, including security fencing and new at-grade road crossings are included in this study.

In discussion with BNSF representatives a permit would be required to bring the existing bicycle trail under the bridge into compliance and make it a viable connecting point on the west side of the bridge. Maintaining this current trail at the same level of access it has enjoyed for the past decade is recommended, but is not critical to the repurposing of the bridge.

The repurposed bridge could be placed in a land trust or railbank which would require use, easement, and maintenance agreements between BNSF and the bridge's managing entity.

Pedestrian safety is of utmost importance to the feasible repurposing of the bridge. At a minimum, 54" metal railings would need to be provided along both edges of the bridge deck for the length of the bridge. The trail will descend from the ends of the truss spans and will require supplemental railroad separation fencing.

It is also common for heavy rail freight bridges that pass through urban areas to have remotely controlled security gates installed at each end of the bridge. This would also help provide positive separation and deter trespassers.

It is understandable that the BNSF would like to reduce bridges with fracture critical members for freight use. The repurposing of the bridge with a shared use trail or pair of trails would have live loading that is significantly less than the typical freight railroad loading. A structural inspection and structural analysis will be required to fully understand the load capacity.

As discussed in section 1.3 there are many examples of pin connected truss bridges repurposed to carry bicyclists and pedestrians. Several other fracture critical truss bridges identified by a similar feasibility study in Minneapolis include, Boom Island Railroad Bridge, Northern Pacific Railroad Bridge No. 9, and Hanover Bridge. Also mentioned in the April report are other similarities stated by the engineer.

“This report acknowledges these concerns, however since 2006 there have been significant developments in understanding and mitigation of structural concerns on fracture critical bridges.” Matthew D. Jensen, PE, April 12th, 2019.

Other risk mitigation strategies are available, and the most appropriate strategy would be identified during the next phase of the project.

03

**OPINION OF PROBABLE  
CONSTRUCTION AND  
MAINTENANCE COST**

### 3.1 Opinion of Probable Costs for Construction and Maintenance



### Opinion of Probable Cost for the Conversion of the BNSF Missouri River Railroad Bridge to a Pedestrian Bridge

Date: 06/24/2019

**OPINION OF PROBABLE COST FOR THE CONVERSION OF THE BNSF MISSOURI RIVER RAILROAD BRIDGE TO A PEDESTRIAN BRIDGE**

MAINTENANCE		EXPECTED LIFE CYCLE	Unit	Qty	UNIT COST	Total	Annual Cost	
1.00	SUPERSTRUCTURE						\$12,750.00	
2.00	SUBSTRUCTURE						\$24,550.00	
3.00	RAILINGS/FENCING						\$5,400.00	
4.00	DECK/PATHS						\$7,800.00	
5.00	INSPECTION/OTHER						\$13,000.00	
							<b>\$63,500.00</b>	
<b>CONSTRUCTION and DESIGN</b>								
1.00	SUPERSTRUCTURE							<u>\$150,000.00</u>
	Patina Coating Truss Span	10	SF	20000	6	\$120,000.00	\$12,000.00	
	Spot Coat Truss Span	40	SF	5000	6	\$30,000.00	\$750.00	
2.00	SUBSTRUCTURE							<u>\$285,500.00</u>
	Clean masonry	15	SF	40000	3	\$120,000.00	\$8,000.00	
	Tuckpoint masonry joints	10	LF	10000	8	\$80,000.00	\$8,000.00	
	Crack injection	10	LF	1500	45	\$67,500.00	\$6,750.00	
	Crack sealing	10	LF	1500	12	\$18,000.00	\$1,800.00	
3.00	RAILINGS/FENCING							<u>\$457,600.00</u>
	Pedestrian Railings/Fencing		LF	3000	120	\$360,000.00		
	Safety/security fencing along trail		LF	2800	30	\$84,000.00		
	Security bollards		EA	1200	8	\$9,600.00		
	Emergency call pole		EA	2000	2	\$4,000.00		
4.00	DECK/PATHS							<u>\$926,000.00</u>
	Overlook decking	50	SF	5000	25	\$125,000.00		
	Bituminous pavement	15	SF	25000	20	\$500,000.00		
	Repair/replace expansion joints	25	SY	6000	3.5	\$21,000.00		
	Accessible Trail Ramps	50	SF	14000	20	\$280,000.00		
5.00	EARTHWORK							<u>\$3,150,000.00</u>
	Grading/Fill		CY	2.25	500000	\$1,125,000.00		
	Wall, Foundation		LF	10000	100	\$1,000,000.00		
	Wall, Finish Material, Premium		SF	25000	35	\$875,000.00		
	Landscape Plantings		SF	30	5000	\$150,000.00		
6.00	ELECTRICAL/LIGHTING							<u>\$80,000.00</u>
	Pedestrian lighting		EA	1500	40	\$60,000.00		
	Electrical		LS	1	20000	\$20,000.00		
7.00	INSPECTION/MAINTENANCE						\$0.00	
	Underwater Inspection & Report	5	LS	1	20000	\$20,000.00	\$4,000.00	
	Fracture critical inspection and report	4	LS	1	50000	\$50,000.00	\$12,500.00	
	Arm's length Masonry Inspection	10	LS	1	15000	\$15,000.00	\$1,500.00	
	Annual Inspection	1	LS	1	4000	\$4,000.00	\$4,000.00	
	Survey	10	LS	1	5000	\$5,000.00	\$500.00	<u>\$94,000.00</u>
Indirects	Design and Plan Preparation				8%			\$400,000.00
	Permitting, Agency, and Construction Services							\$200,000.00
							<b>SUBTOTAL</b>	\$5,743,100.00
							<b>TOTAL *</b>	<b>\$6,891,720.00</b>

\* with 20% contingencies

### 3.2 Conceptual Alignments and R/W Needs for Connecting Trails



### 3.3 Connections to Existing Morton County Trails



[figure 11.1] west ramp connection



[figure 11.2] east ramp connection

### 3.4 Connecting to a Future Expansion of a Cultural Trail System

Trail Route : Option 1	Trail Distances	Typology	Trail Route : Option 1
Ramp Exit to Shafer Street	0.48 mi	trail	<b>From Trailhead:</b>
Shafer Street to Divide Avenue	0.89 mi	on-street	To Capitol Grounds   2.79 mi
Divide Avenue to Capitol Grounds	1.42 mi	on-street	To Bismarck Library   3.8 mi
Through Grounds to 5th Street	1.95 mi	shared-path	To Bismarck Train Depot   4.38 mi
5th Street to Bismarck Library	0.48 mi	on-street	To Riverfront Trail   5.08 mi
Bismarck Library to Train Depot			<b>Loop Connection :</b>
- Via 5th St. to Main Ave.	0.58 mi	on-street	Mandan Missouri River Mountain
Train Depot [9th Ave] to EXPWY	0.7 mi	on-street	Bike Trail   7.74 mi
EXPWY to Riverfront Trail			<b>Trail Total   7.74 mi</b>
- Via Main Ave.	2.66 mi	trail	
Trail Route : Option 2	Trail Distances	Typology	Trail Route : Option 2
Ramp Exit to Edwards Avenue	0.23 mi	trail	<b>From Trailhead:</b>
Edwards Avenue to Shafer Street	0.65 mi	on-street	To Capitol Grounds   3.34 mi
Shafer Street to Divide Avenue	1.04 mi	on-street	To Bismarck Library   4.35 mi
Divide Avenue to Capitol Grounds	1.42 mi	on-street	To Bismarck Train Depot   4.93 mi
Through Grounds to 5th Street	1.95 mi	shared-path	To Riverfront Trail   5.63 mi
5th Street to Bismarck Library	0.48 mi	on-street	<b>Loop Connection :</b>
Bismarck Library to Train Depot			Mandan Missouri River Mountain
- Via 5th St. to Main Ave.	0.58 mi	on-street	Bike Trail   8.29 mi
Train Depot [9th Ave] to EXPWY	0.7 mi	on-street	<b>Trail Total   8.29 mi</b>
EXPWY to Riverfront Trail			
- Via Main Ave.	2.66 mi	trail	

[figure 12.0] future cultural trail options and distances

FORB Cultural Trails Proposal  
Bismarck, North Dakota

# 04

**ACTION PLAN  
AND SCHEDULE**

## 4.1 Project Schedule and Timeline:

The Friends of the Rail Bridge will be the agency to lead the interest and coordination of partners for the potential repurposing of the BNSF Missouri River Railroad Bridge.

### Potential Project Schedule:

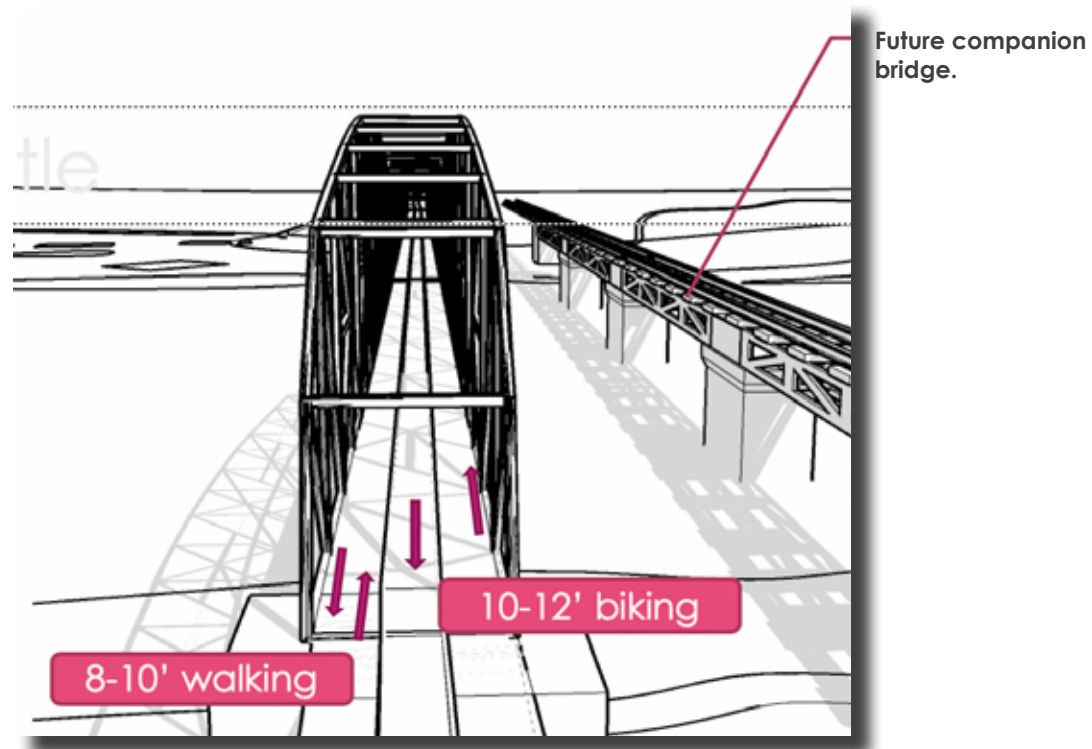

[figure 13.0] bridge conceptual alignments, allows for several AASHTO compliant configurations - to be determined during design phase.

## 4.2 Potential Sponsors/Governance

### Potential Partners for Funding, Ownership, and/or Maintenance :

- Bismarck Parks & Recreation District
- Morton County Parks District
- City of Bismarck
- City of Mandan
- North Dakota Department of Transportation
- Bismarck State College
- Northern Plains National Heritage Area
- The National Trust for Historic Preservation
- Friends of the Rail Bridge
- The Missouri Valley Heritage Alliance
- North Dakota State Historic Site
- North Dakota Department of Parks & Recreation

\* This is not an exclusive list - many national funding sources are also available, due to the recent national visibility of the bridge.

## 4.3 Funding

### Potential Funding Sources:

- **BNSF** Cost and tax savings payment to Friends of the Rail Bridge by avoiding demolition and tax-deductible sale of multi-million bridge asset
- **North Dakota Outdoor Heitage Fund**
- **Federal Lands Access Program**
- **US Fish and Wildlife Service** Through a Federal Land Transportation Program Grant
- **Bismarck Parks and Recreation District** One-time cash in lieu of maintenance payment
- **Morton County Parks District** One-time cash in lieu of maintenance payment
- **The Bush Foundation** Support for community organizations for several years of expenses. [www.bushfoundation.org](http://www.bushfoundation.org)
- **The BNSF Railway Foundation** “primarily supports non-profits in communities located on our 32,500-mile rail network. The Foundation’s giving has expanded to help more and more communities.” [www.bnsffoundation.org](http://www.bnsffoundation.org)
- **FORB 501(c)3 Fundraising** Community support for capital campaigns has a strong record in the Bismarck Mandan community.
- **Philanthropic partner entities of the National Trust for Historic Preservation.** The trust has over 300,000 active members and an expansive network of philanthropists from across the nation and world. That the bridge is listed on the 2019 11 Most Endangered Places has elevated it to the audience and potential funders within this group.

**\* This is not an exclusive list - many national funding sources are also available, due to the recent national visibility of the bridge.**

## 4.4 Public Input

The Section 106 consulting parties, the Friends of the Rail Bridge, The Advisory Council on Historic Preservation, The National Trust and The North Dakota State Historic Preservation Office have collaborated and prioritized stakeholder and public input. The Friends of the Rail Bridge conducted several public input and information meetings prior to this study.

### Stakeholders Included :

- **City of Bismarck: Elected Officials and Staff**
- **Captain’s Landing Township Representatives**
- **Bismarck Parks and Recreation District**
- **Morton County Park Officials**
- **U.S. Coast Guard Officials**
- **Advisory Council on Historic Preservation**
- **Historic Bridge Foundation**
- **BNSF**

Further coordination to guide the evaluation and decision making process is needed and should include but is not limited to; genuine and meaningful consultation with tribal nations, including Tribal Historic Preservation Offices and other heritage stakeholders.

## 4.5 Summary of Findings and Opinion of Feasibility



### Economic Feasibility:

The community support, historic value, National Trust for Historic Preservation designation as one of 11 most endangered properties, and improvement to the needs of the community have been well documented by multiple studies. In considering the feasibility of re-purposing the BNSF Missouri River Railroad Bridge for bicycle and pedestrian systems within an active, year-round outdoor recreation corridor, the largest impacts are agreements with BNSF, cost and environmental impacts of accommodating both a new rail line and keeping in place the historic bridge piers. Considering that the demolition cost of the rail bridge is comparable to that of accessibility and initial upgrade costs, re-purposing the bridge for bicycle and pedestrian use is feasible from a cost perspective. Furthermore, a market study update completed by Kadrmas Lee & Jackson of Bismarck, ND, RDG Planning and Design of Omaha, NE, and Agency MABU of Bismarck, ND show a need for a physical trail connection at the study location, and a market gap in excess of \$55 million dollars for the area directly west of the Missouri River Rail Bridge. The establishment of the Friends of the Rail Bridge entity, the market demand for development on both sides of the Missouri River Rail Bridge and the funding sources listed in Section 4.3 make the project economically feasible.

### Cultural Feasibility:

As noted in the Class II Cultural Resource Inventory, the historic bridge lies within one mile of 49 previously recorded cultural resources, and in alignment with the city centers of Bismarck and Mandan, ND. If the rail bridge becomes the catalyst for a cultural trail linking the findings of the Mandan Memorial Highway Corridor Study and call for Riverfront development proposals by the City of Bismarck it is feasible that a surge in cultural and economic investments will follow. Similar cultural trail projects such as the Indianapolis Cultural Trail and the Minneapolis Stone Arch Bridge Trail have seen economic impacts in excess of \$1 billion and include the creation of 1,000s of new jobs.

From the Mandan Memorial Highway Corridor and Market Study, "The Corridor Study used a planning process focusing on community-based values and goals of all interest and stakeholders."

As recommended in the Corridor Study Figure 5.9 Alternate 1. "The new development connects to development on the other side of the Interstate (Captain's Landing area) via a pedestrian overpass." (pg. 70) This pedestrian overpass is in alignment with the Bismarck Missouri River Railroad Bridge and would provide a direct bicycle and pedestrian link as well as a truly unique experience of the Missouri River and sister cities.

Furthermore, from Cheryl McCormac's Bismarck Tribune article, Riverfront development a focus of Bismarck's call for projects, "Riverfront development appeared 'again and again' in the more than 1,100 responses Bismarck received when conducting its strategic plan survey last fall." And in the call for proposals "complete connectivity" encompasses

communications, walking and biking and neighborhood connections." Bismarck Mayor Bakken "wants the 1883 Burlington Northern Sante Fe Rail Bridge to be a part of the plan," according to Bismarck Tribune, January 21st, 2019.

Finally, The City of Bismarck adopted the Downtown Bismarck Sub-area Plan in December 2013 and this plan is supported by the December 2017 Bismarck – Mandan Bicycle and Pedestrian Plan completed by Stantec, Bartlet and West and the University of Minnesota for the Bismarck Mandan Metropolitan Planning Organization. The plan calls for "several improvements to connect the downtown to the wider bicycle and pedestrian network, including a rails-with-trails connection to the riverfront trails along the south side of the existing railroad track....and utilizing the historic rail bridge." The Bismarck Parks and Recreation District had a \$15,994,452 in general fund revenue in 2018 and \$376,505 in other financing sources. We agree with the findings of the 3 previously mentioned studies and find that the project is culturally supported and feasible.

### Environmental Feasibility:

The environmental feasibility of re-purposing the historic rail bridge in addition to the construction of a new BNSF rail bridge would require a new Conditional Letter of Map Revision (CLOMR) 17-08-1412R. FEMA does not have the direct authority to issue a variance to local floodplain regulations. However, per FEMA's website; "FEMA's EHP experts provide specialized guidance and practical long-term planning assistance to communities across the county to ensure that proposed projects align with environmental planning and preservation requirements." This will be of great benefit for the Friends of the Rail Bridge entity moving forward.

Under 44 CFR 60.6, the community is the one to approve any exemptions from the National Flood Insurance Program (NFIP) floodplain management requirements, including those related to historic properties. Thus, Bismarck/Mandan or Friends of the Rail Bridge would need to submit updated engineering data.

Because FEMA does not mandate a particular engineering solution a new CLOMR request with appropriate supporting engineering data could make the project environmentally feasible. Alternatively, an application to determine a categorical exclusion for the purposes of the National Environmental Policy Act (NEPA) could be sought because the project and Cultural Resources Survey may satisfy criteria for actions listed in the Coast Guard's NEPA Implementing Instructions. (See appendix I. for a recent 2019 example).

### Opinion of Feasibility:

This study finds sufficient evidence of support from both community stakeholders and outside experts for the local Floodplain Administrators to agree to participate in the re-evaluation of a scenario where a new BSNF bridge is constructed and the historic rail bridge is re-purposed as a bicycle and pedestrian crossing.

Given this evidence and the cultural and economic sources available in the Bismarck Mandan market it is the opinion of the study team that it is feasible to re-purpose the existing historic Northern Pacific Railroad bridge into a pedestrian and bicycle path with BNSF's proposed new bridge in place thirty feet to the north or, alternately, eighty feet to the north.

## 4.6 Disclaimer

NDSU Landscape Architecture as part of its land grant mission was retained to perform this feasibility study according to a specifically stated scope of services. The contents of the report are based on compiled data from drone observations obtained from locations observed by the Landscape Architect. It is possible that all conditions were not visually detected by the Landscape Architect. This report is for the exclusive use of the client.

No warranty is made, express or implied, that deficiencies that may affect life or safety may not exist. Drawings included in this study are not for construction purposes.

# APPENDICES A-I

# A

## APPENDIX A Location Map

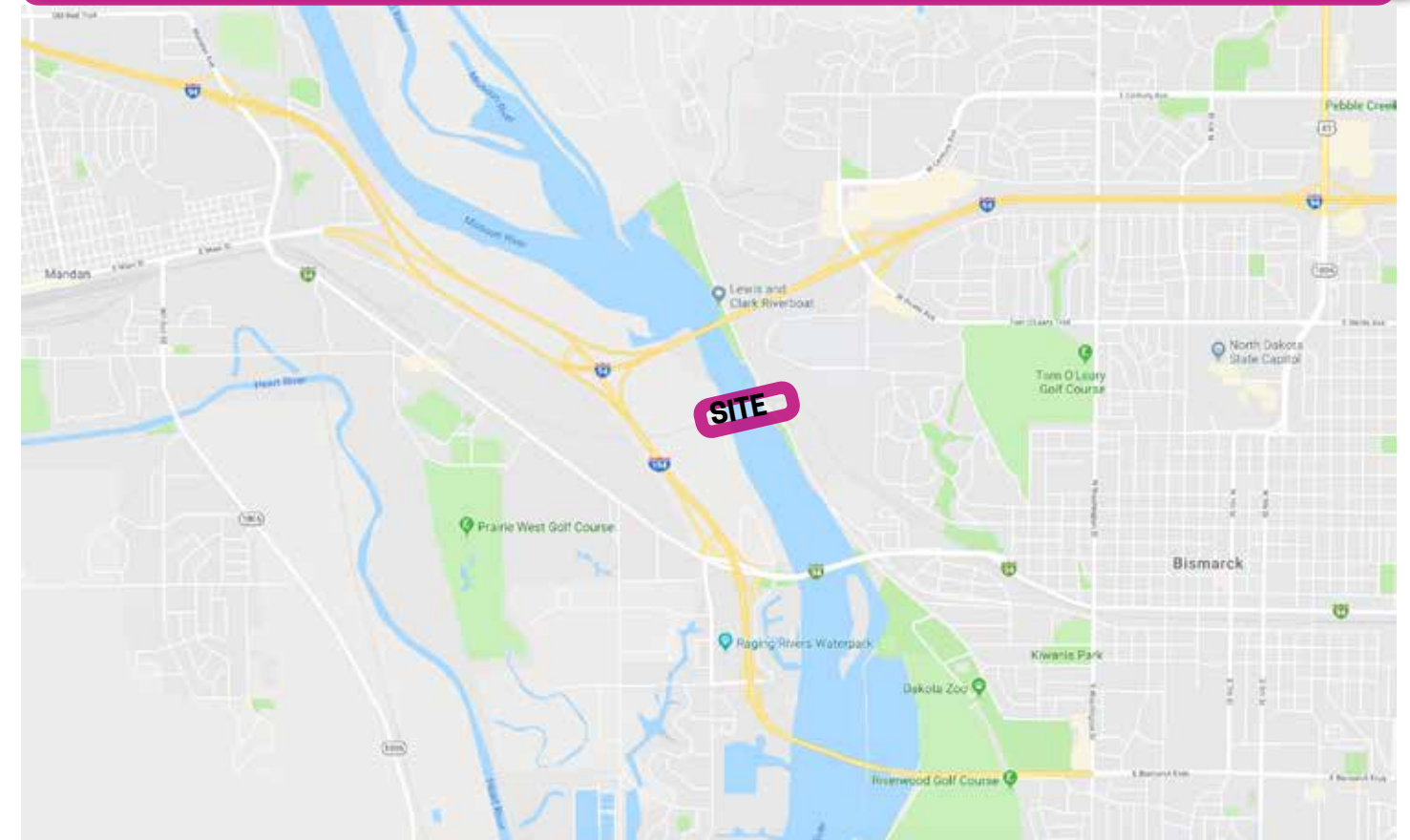

APPENDIX B Photos

# B



EXHIBIT B.1 - AERIAL VIEW FACING WEST

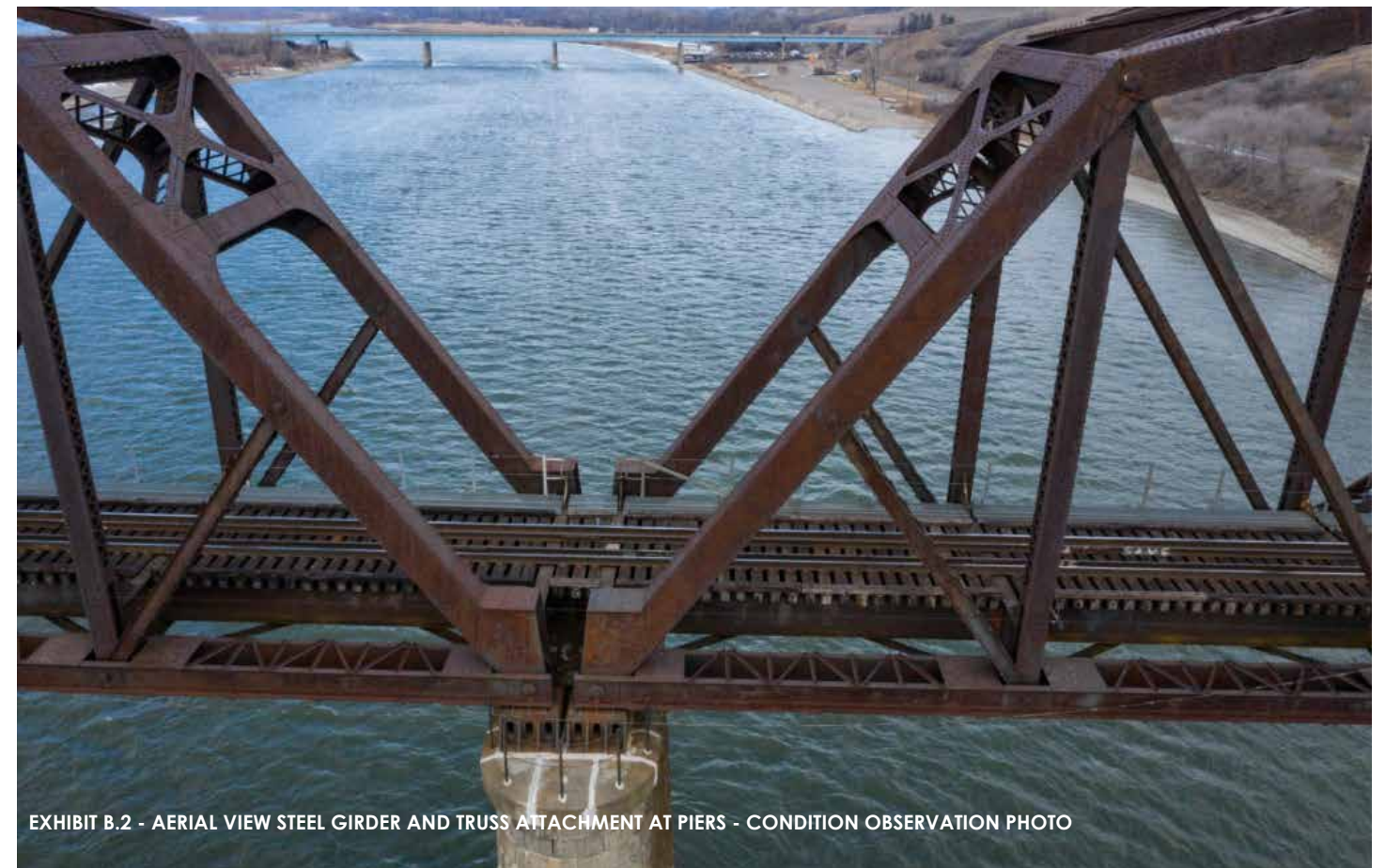

EXHIBIT B.2 - AERIAL VIEW STEEL GIRDER AND TRUSS ATTACHMENT AT PIERS - CONDITION OBSERVATION PHOTO



EXHIBIT B.3 - AERIAL VIEW FACING BSC



EXHIBIT B.5 - AERIAL VIEW SHOWING EAST ACCESS ROAD

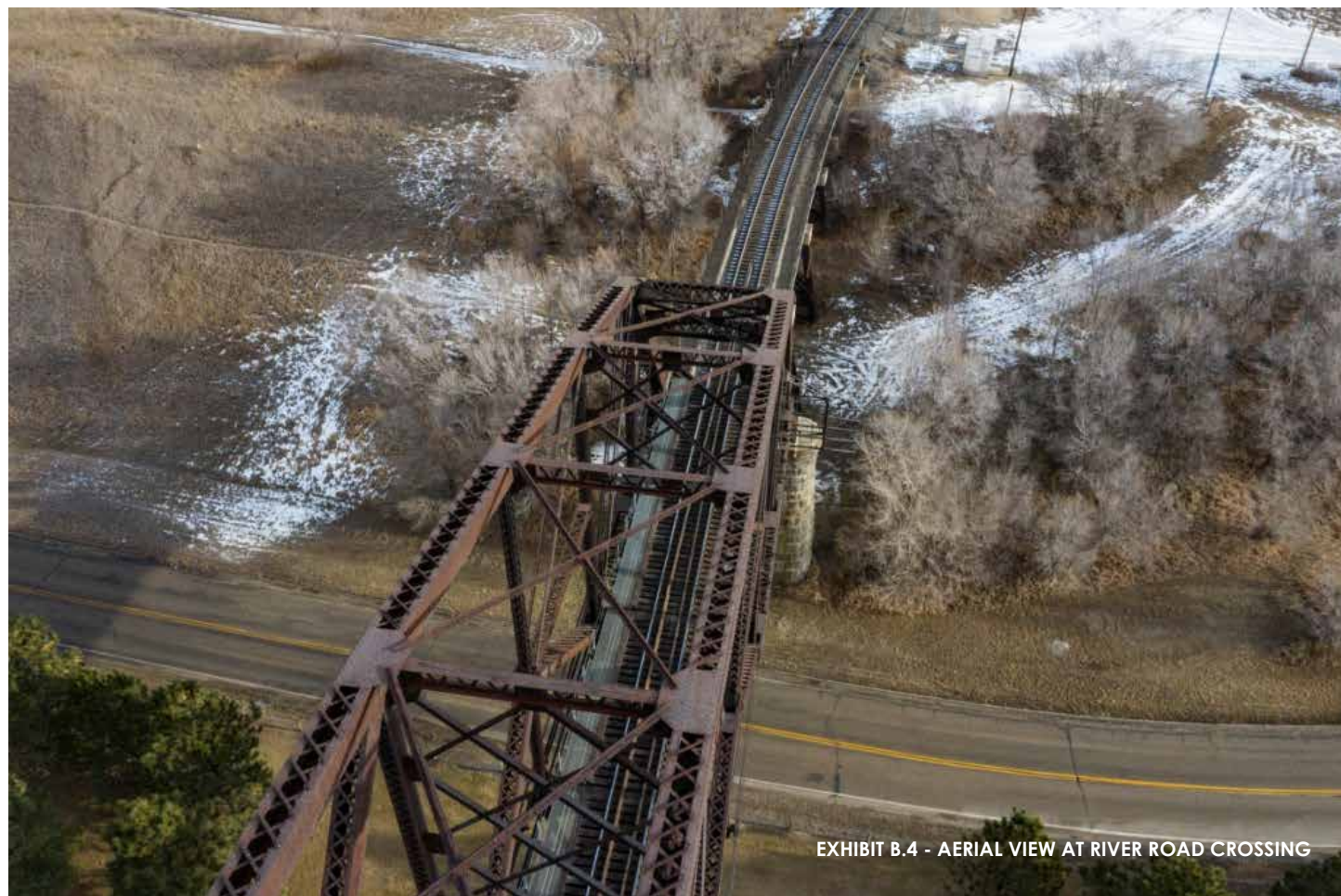

EXHIBIT B.4 - AERIAL VIEW AT RIVER ROAD CROSSING

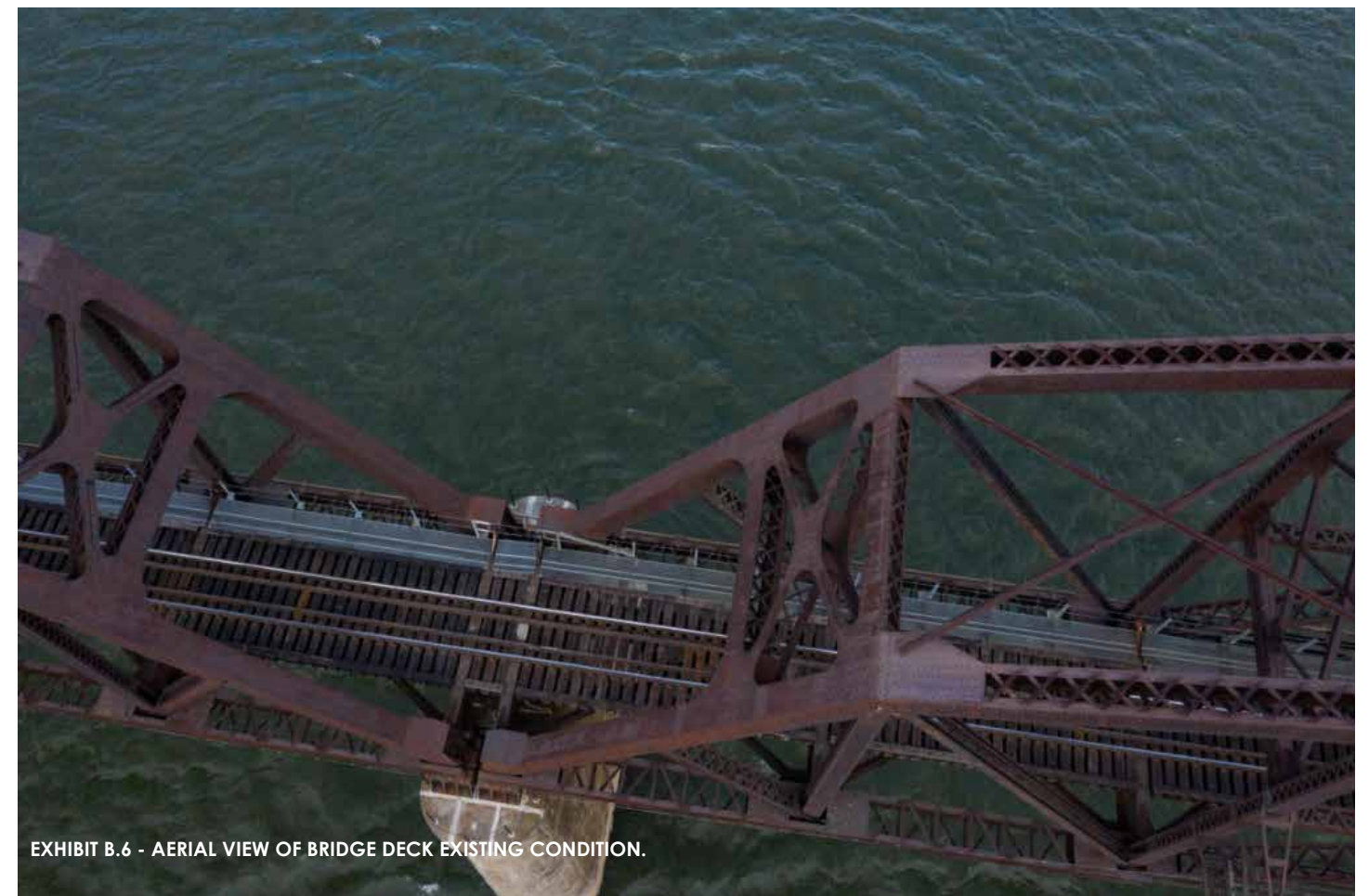

EXHIBIT B.6 - AERIAL VIEW OF BRIDGE DECK EXISTING CONDITION.

## APPENDIX C Preliminary Site Plans



## APPENDIX D Steering Review Committee Comments



1) Susan Wefald

After looking at the Draft Feasibility Study (75% complete) dated March 5, I have the following suggestion:

Bismarck State College with approximately 3,800 students is immediately adjacent to the proposed historic 1883 rail bridge recreation trail. Gateway to Science is planning a \$30 million new science center to educate children, young adults, and their parents to STEM activities west of the college bowl on the BSC campus. I suggest we include in our feasibility study the cost of connecting the rail bridge recreation trail to the Bismarck State College Campus. If well connected, students (including Gateway to Science students) could access the natural area on the west side of the bridge for STEM activities. Also, students could use the recreation trail for physical education training. In the report, we have not mentioned Bismarck State College or Gateway to Science as possible partners.

I thought of this concept when I recently visited Pensacola, Florida. The University of West Florida in Pensacola, Florida has established a partnership with a historic district in Pensacola Florida. The University of West Florida Historic Trust is dedicated to collecting, preserving, interpreting and sharing the history of NW Florida. The University of West Florida Historic Trust provides students an opportunity to live, work and study in a National Register Historic District. Perhaps something similar could be considered for BSC and the Northern Plains National Heritage Area, of which the historic rail bridge is an important part. But first, we need to see if it is feasible to connect the bridge to the BSC campus.

2) David Mayer (Comments 4.4.19 and 6.17.19)

Construction and Design Deck/paths – Asphalt pavement will not last 50 years. At best we are lucky to get 15 years before the trail would need to be replaced or an overlay would need to occur. With a structure I don't know that overlaying is possible. Adjusting the lifespan of the asphalt for the ramps down to 15 would be more realistic. Also, not accounted for in the estimate is the connection to the trail system and required pedestrian crossing at River Road. The plan should address crossing River Road, there could be extensive cost implications.

Section 3.1 Opinion of Probable Costs...

As mentioned above in 1.3, long-term costs are not accounted for. This estimate looks at conversion to a pedestrian bridge and possible maintenance. Shouldn't it also discuss a savings or trust account to handle future major renovations/repairs?

3.2 Connections

On the Bismarck side the ramp ends at River Road and does not connect to the existing trail system. The design should include a connection to the existing trail system along the river. Along the west bank the ramp ends in a ditch, this document should discuss the connections to the community and how that will occur. The estimate should include those costs as well.

4.4 Public Input - Please change the word "Officials" at the end of Bismarck Parks and Recreation District to representatives. This is more accurate wording.

Overall document comment:

Throughout this draft, multiple agencies are listed as possible responsible parties, sponsors/governance and potential funding sources. Prior to completing this document, it would be prudent to discuss these topics with these entities representatives prior to naming them in these categories. Knowing these organizations stance on these topics ahead of time may change the statement in section

4.5, Summary of Findings and Opinion of Feasibility.

Reference sections: 2.2, 4.2 and 4.3 4.5 Summary of Findings and Opinion of Feasibility Not knowing BNSF's requirements in 2.4 and 2.5 it seems premature to make a case for feasibility. Another question that should be asked of BNSF is, what does BNSF want from that entity in terms of cost and indemnification of future claims?

3) Bob Shannon (5.21.19)

The maps showing roads and trails should reflect the existing and planned trail system as a starting point, as shown by the Bismarck Mandan Metropolitan Planning Organizations bike/ped master plan (which is available on the City of Bismarck's website under Growth Mgmt).

As FORB is a non profit group, the proposed improvements should be identified as those improvements necessary to have a barebones functional trail on the repurposed bridge (with some connection to the nearest existing trails). Then any improvements that could be added later could be identified so that they would be implemented as additional funding/partnerships are identified.

The preliminary cost estimates included painting the bridge...is this necessary? The preliminary cost of bridge painting appeared low.

The preliminary cost estimates included 'cleaning' of the stone piers...has there been any thought that we should preserve the patina rather than spend a lot of money on something that isn't necessary?

The preliminary cost estimates included 500,000 cubic yards of embankment at \$1/c.y. ....Embankment borrow that is \$1/c.y. is typically moved a short distance within a road R/W by a scraper, not trucked to the site. The proposed new RR bridge is only using 200,000 c.y. of embankment, and all of it is to be trucked in borrow that creates huge logistics issues and high cost (\$15/c.y. or more). Captains Landing Township will not allow the borrow to be trucked over their roads, and there are no other access points to the west side of the bridge. The railroad has proposed a temporary access off of the I-194 northbound lanes, which the NDDOT will only accommodate during a construction project on I-194 this summer. That temporary access involves significant expense to just construct the access point...and it will be removed after 90 days, so the access will not be available for later construction. Without the access, the railroad was considering the use of barges to bring embankment and materials to the work site. The amount of estimated embankment needed should be split out as to which side of the river it is needed, and for what specific improvements.

The proposed typical section for the bridge include 8' wide exclusive bike lanes, a landscaped median and a separate pedestrian trail with fences/rails alongside. However, it appears this does not meet the AASHTO bicycle facility design guidelines and may not qualify for some federal aid programs. Trails typically have a 2'-3' shyway along either sides of trails...putting bicycles on a high structure with no shyway along an 8' wide trails seems like there may be inadequate space for the trail users. The landscaped median is nice but brings higher maintenance and construction costs, as well as questionable ability to water anything. Could this be reconsidered to provide a trail section that is cost efficient while also meeting the AASHTO design guide?



The City of Bismarck will limit its comments on the BNSF Rail Bridge Feasibility Study to subject matters that relate directly to the City of Bismarck's infrastructure, in particular, the Water Treatment Plant and related facilities in the vicinity of the BNSF rail bridge. The City of Bismarck does not manage/maintain/operate the existing multi-use trail facilities adjacent to the rail bridge. Therefore, the City of Bismarck does not have a position to take in regard to the feasibility of repurposing the bridge to a bicycle/pedestrian facility in concert with existing trail networks.

At this time, and based on the information contained in the draft report, the City of Bismarck will not be expending any funds toward the repurposing of the rail bridge for reasons stated previously. The Commission indicated that any official comments or discussion with the City will go through City Administration, who will bring the appropriate information to the City Commission to make any formal decisions.



# APPENDIX E Preliminary Cost Estimates [Structures]

Date: 06/24/2019

## OPINION OF PROBABLE COST FOR THE CONVERSION OF THE BNSF MISSOURI RIVER RAILROAD BRIDGE TO A PEDESTRIAN BRIDGE

MAINTENANCE		EXPECTED LIFE CYCLE	Unit	Qty	UNIT COST	Total	Annual Cost	
1.00	SUPERSTRUCTURE						\$12,750.00	
2.00	SUBSTRUCTURE						\$24,550.00	
3.00	RAILINGS/FENCING						\$5,400.00	
4.00	DECK/PATHS						\$7,800.00	
5.00	INSPECTION/OTHER						\$13,000.00	
							<b>\$63,500.00</b>	
<b>CONSTRUCTION and DESIGN</b>								
1.00	SUPERSTRUCTURE							<u>\$150,000.00</u>
	Patina Coating Truss Span	10	SF	20000	6	\$120,000.00	\$12,000.00	
	Spot Coat Truss Span	40	SF	5000	6	\$30,000.00	\$750.00	
2.00	SUBSTRUCTURE							<u>\$285,500.00</u>
	Clean masonry	15	SF	40000	3	\$120,000.00	\$8,000.00	
	Tuckpoint masonry joings	10	LF	10000	8	\$80,000.00	\$8,000.00	
	Crack injection	10	LF	1500	45	\$67,500.00	\$6,750.00	
	Crack sealing	10	LF	1500	12	\$18,000.00	\$1,800.00	
3.00	RAILINGS/FENCING							<u>\$457,600.00</u>
	Pedestrian Railings/Fencing		LF	3000	120	\$360,000.00		
	Saftey/security fencing along trail		LF	2800	30	\$84,000.00		
	Security bollards		EA	1200	8	\$9,600.00		
	Emergency call pole		EA	2000	2	\$4,000.00		
4.00	DECK/PATHS							<u>\$926,000.00</u>
	Overlook decking	50	SF	5000	25	\$125,000.00		
	Bituminous pavement	15	SF	25000	20	\$500,000.00		
	Repair/replace expansion joints	25	SY	6000	3.5	\$21,000.00		
	Accessible Trail Ramps	50	SF	14000	20	\$280,000.00		
5.00	EARTHWORK							<u>\$3,150,000.00</u>
	Grading/Fill		CY	2.25	500000	\$1,125,000.00		
	Wall, Foundation		LF	10000	100	\$1,000,000.00		
	Wall, Finish Material, Premium		SF	25000	35	\$875,000.00		
	Landscape Plantings		SF	30	5000	\$150,000.00		
6.00	ELECTRICAL/LIGHTING							<u>\$80,000.00</u>
	Pedestrian lighting		EA	1500	40	\$60,000.00		
	Electrical		LS	1	20000	\$20,000.00		
7.00	INSPECTION/MAINTENANCE						\$0.00	
	Underwater Inspection & Report	5	LS	1	20000	\$20,000.00	\$4,000.00	
	Fracture critical inspection and repo	4	LS	1	50000	\$50,000.00	\$12,500.00	
	Arm's length Masonry Inspection	10	LS	1	15000	\$15,000.00	\$1,500.00	
	Annual Inspection	1	LS	1	4000	\$4,000.00	\$4,000.00	
	Survey	10	LS	1	5000	\$5,000.00	\$500.00	<u>\$94,000.00</u>
Indirects	Design and Plan Peparation				8%			\$400,000.00
	Permitting, Agency, and Construction Services							\$200,000.00
							<b>SUBTOTAL</b>	<b>\$5,743,100.00</b>
							<b>TOTAL *</b>	<b>\$6,891,720.00</b>

\* with 20% contingencies



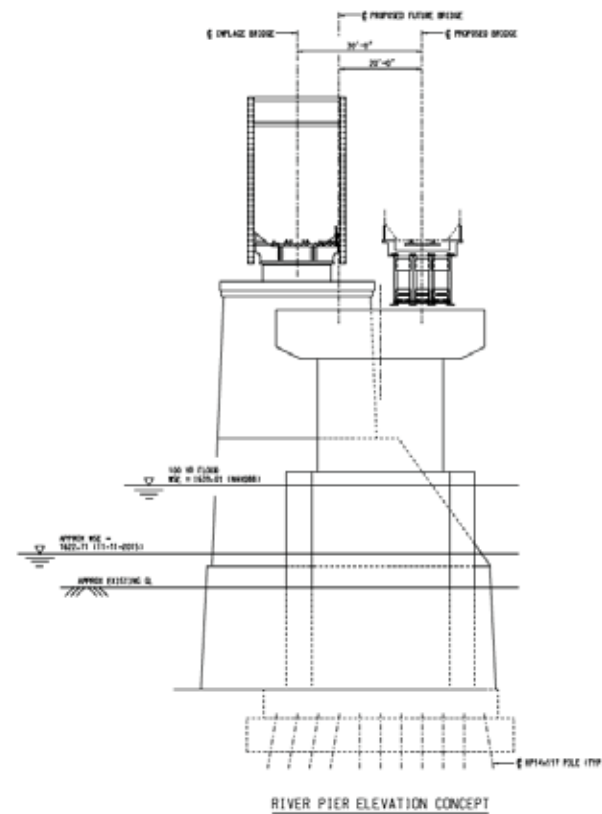
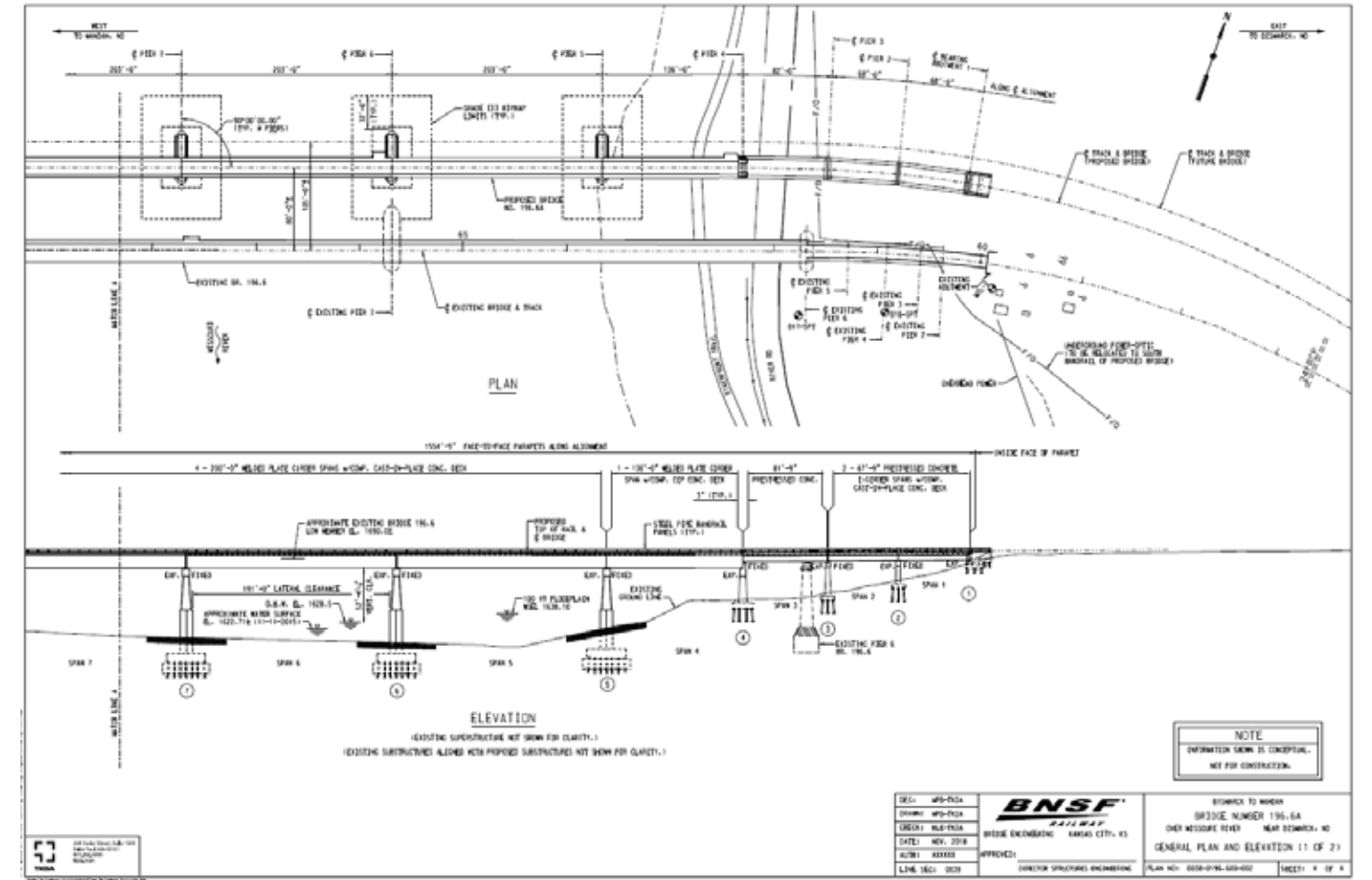
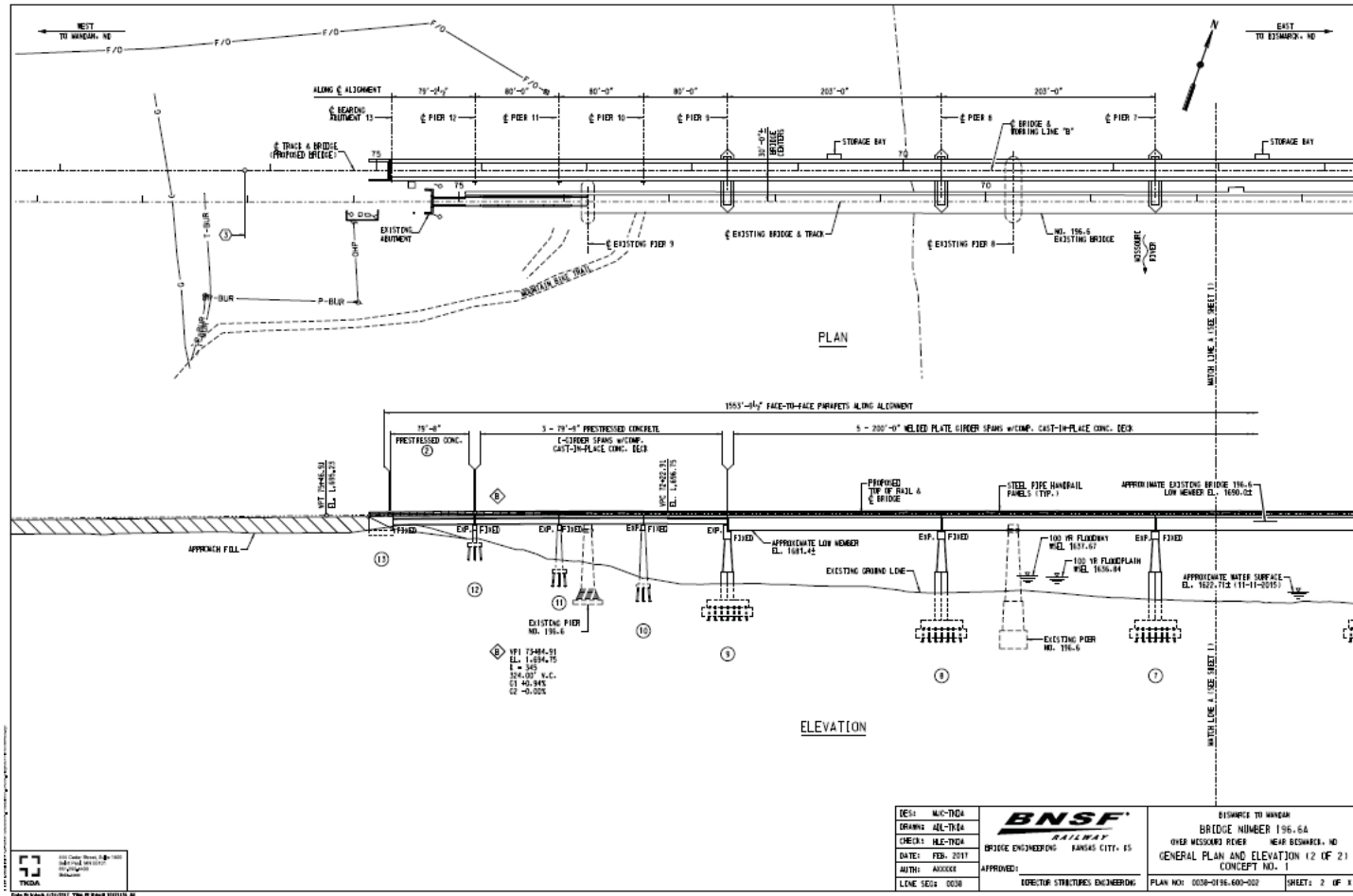

DESIGN: MFC/TCM		STATION TO WAGON
DRAWING: MFC/TCM		BRIDGE NUMBER 196-6A
CHECKED: MFC/TCM		OVER MISSOURI RIVER NEAR BETHANY, MO
DATE: NOV. 2017		RIVER SPAN PIER CONCEPT
AUTH: AXXXX		CONCEPT NO. 1
LINE SECT: 000	APPROVED: DIRECTOR STRUCTURAL ENGINEERING	PLAN NO: 000-016-000-004 SHEET: 01 OF 01

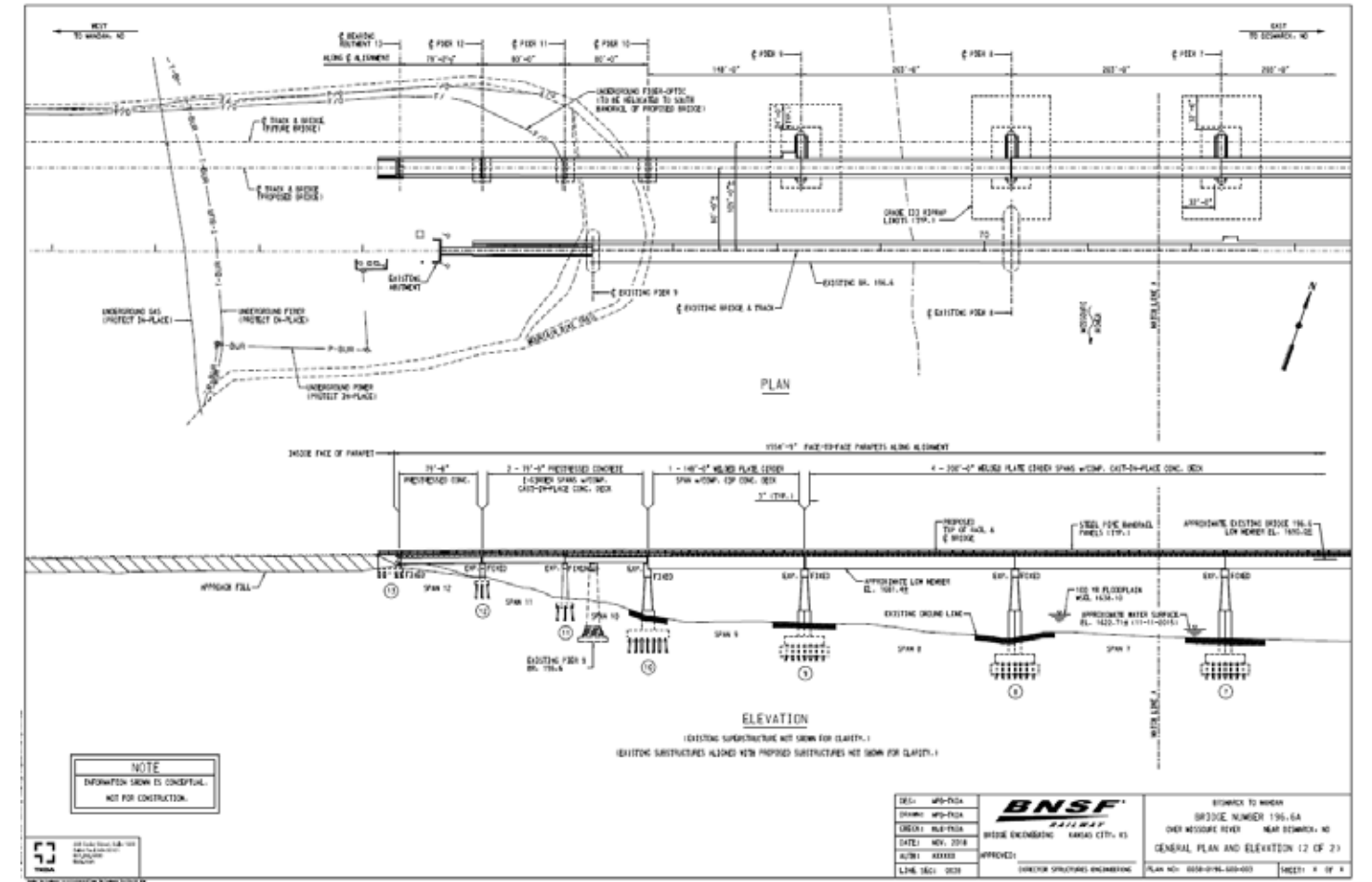

# Design Concept Comparison

1. Cost – Premium cost of \$25M-\$30M to construct alternate design concept
  - \$19.4M – Retaining wall along Missouri River Nature Preserve
  - \$5M – Grading
  - \$4.3M – Relocation of rail bridge over expressway
2. Risk – BNSF’s preferred design concept minimizes risk of soil movement
  - Excavation for existing bridge initiated chronic soil/bridge pier movement
  - Alternate concept requires significant excavation of embankment in NE quadrant
3. Schedule – Alternate design concept adds 2-3 years to project schedule
  - Design of added scope
  - Significant increase in scope of construction

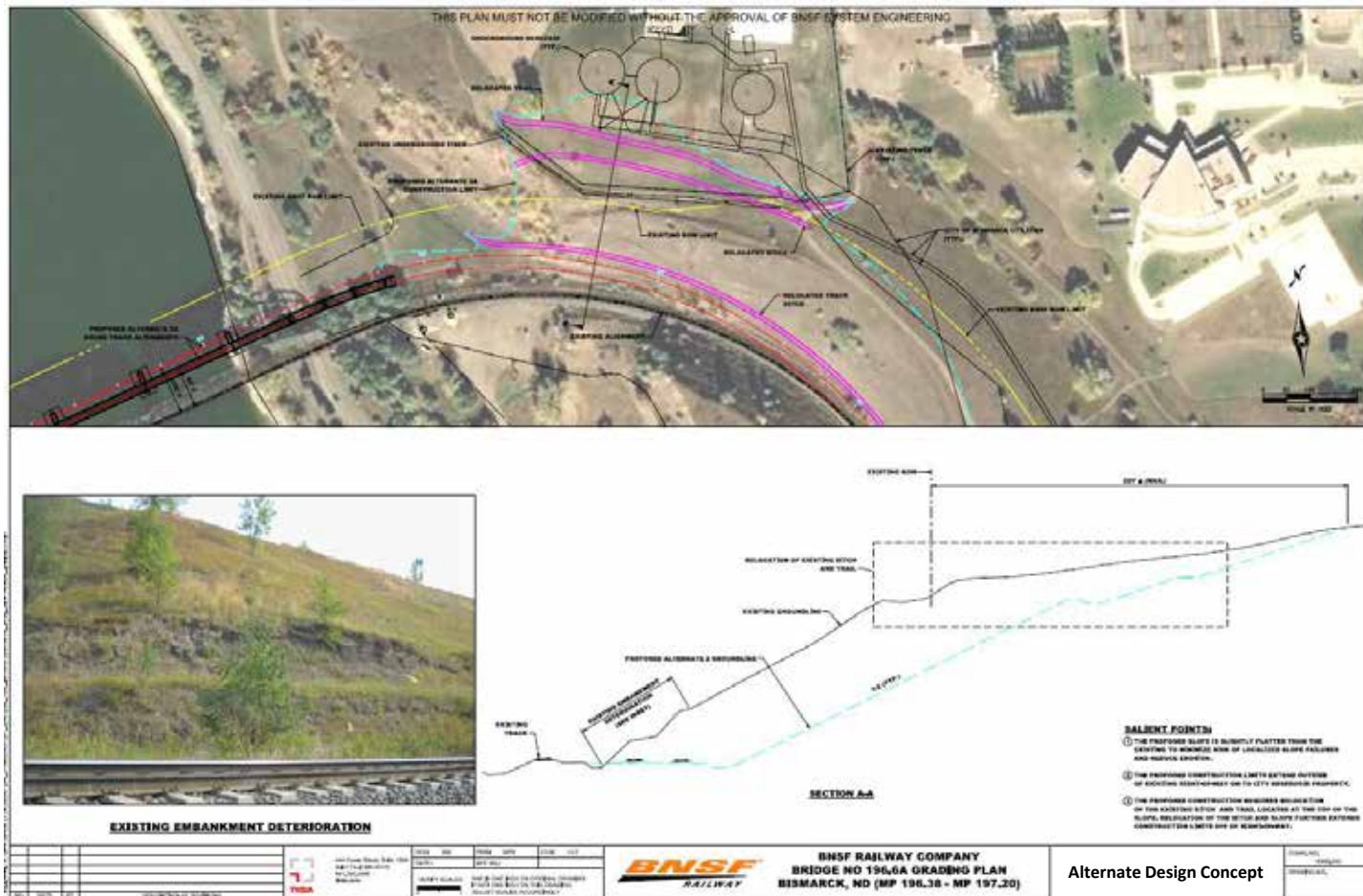
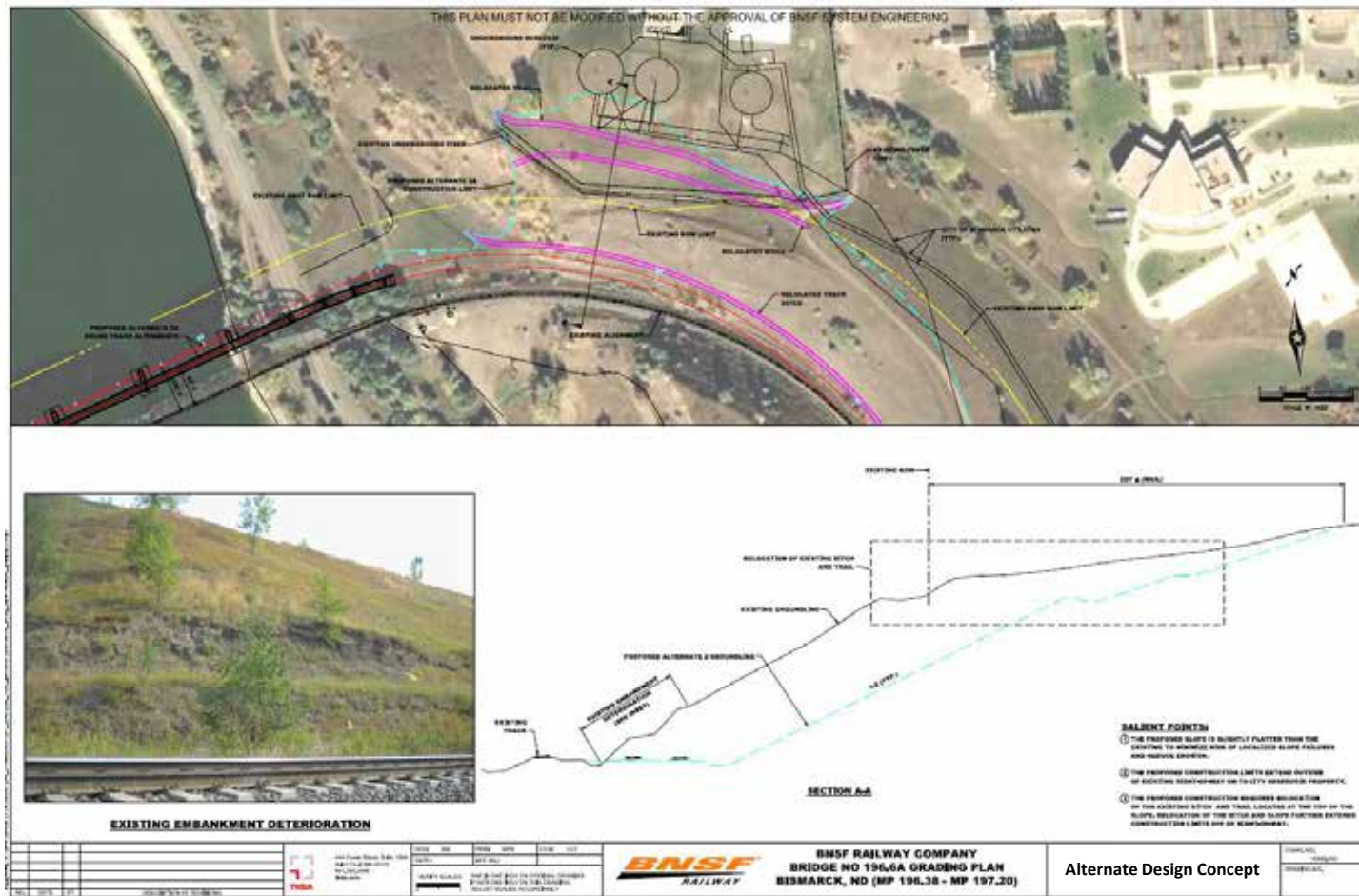

# Hydraulic Modeling Summary

- **Case A** - BNSF Preferred Design WITHOUT Existing Bridge - Tracks positioned on existing alignment and 30' north:
  - Yields a no-rise in base flood elevation.
  - No structures impacted by base flood.
- **Case B** – New bridge with tracks positioned 80' and 105' north of existing bridge WITH existing bridge, and every other new “wet” pier aligned with an existing pier:
  - Yields a base flood elevation rise of 0.02'.
  - Rise extends eight miles upstream and impacts approximately 500 structures.
- **Case C** - BNSF Preferred Design WITH Existing Bridge - Tracks positioned on existing alignment and 30' north of existing bridge, and all new piers offset from existing piers:
  - Yields a base flood elevation rise of 0.03'.
  - Rise extends ten miles upstream and impacts approximately 550 structures.

# Cost and R/W Implications

- **Case A** - BNSF Preferred Design with no rise in base flood elevation:
  - Provides baseline cost for comparison to Cases B and C.
  - All work is within BNSF R/W.
- **Case B** - Base flood elevation rise of 0.02':
  - Requires a cost premium of \$32M compared to Case A:
    - \$23.7M to construct modified bridge design.
    - \$8.4M to achieve a no-rise base flood elevation rise. (See slide #4)
  - Requires significant work outside of BNSF R/W.
- **Case C** - Base flood elevation rise of 0.03':
  - Requires an added premium cost, in excess of the \$8.4M, to achieve a no-rise base flood elevation rise.
  - Work to achieve no-rise base flood extends further off BNSF R/W than required for Case B.



2

## Case B Mitigation – Base Flood Elevation Rise 0.02'

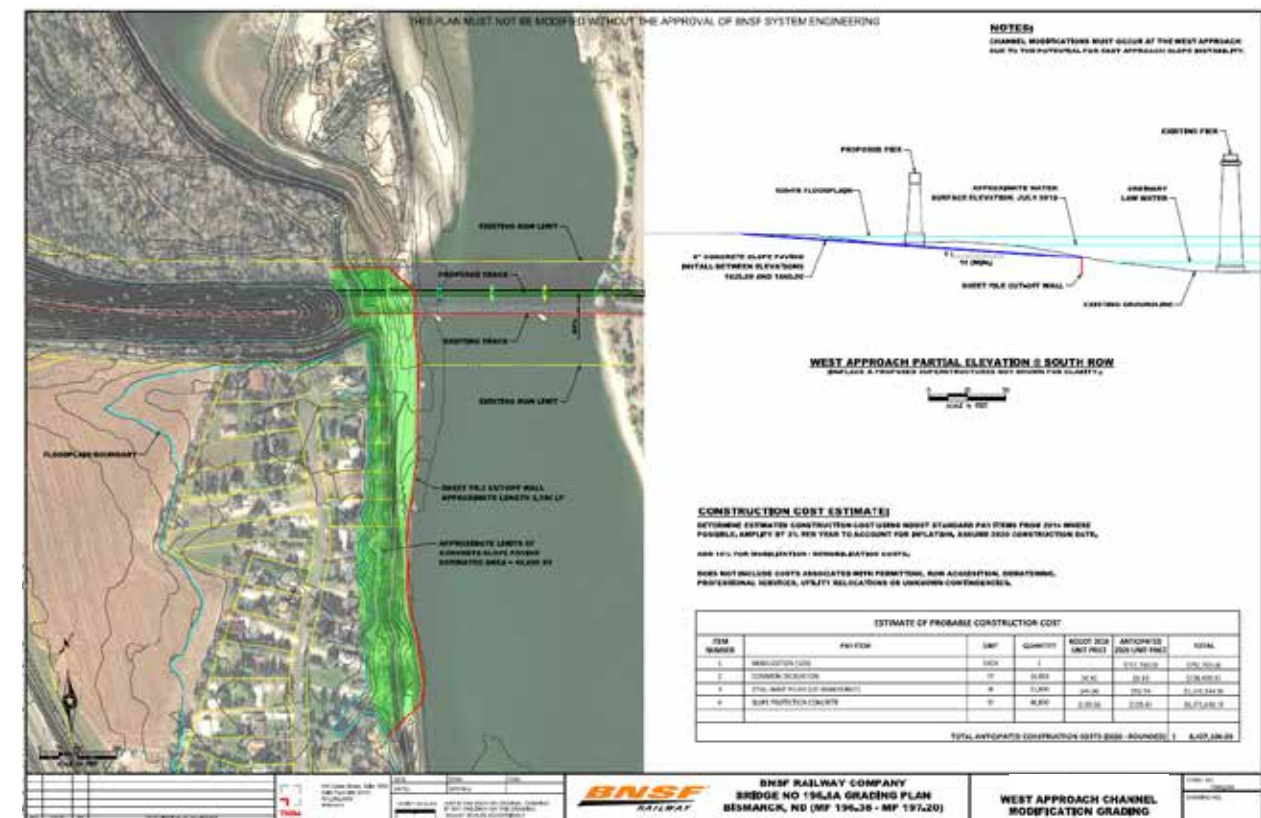



The screenshot shows the top of a webpage from the National Trust for Historic Preservation. At the top left is the organization's logo. To its right is a navigation menu with links for 'Stories', 'Places', 'Our Work', and 'Support'. On the far right is a circular graphic with the text 'America's 11 Most Endangered Historic Places'. Below the navigation is the article title 'Discover America's 11 Most Endangered Historic Places for 2019' dated May 30, 2019. A sub-header indicates '11 Most Endangered Historic Places' by the National Trust for Historic Preservation. There are social media share buttons for Facebook, Twitter, and email. The main text begins with 'Each year, America's 11 Most Endangered Historic Places sheds light on important examples of our nation's heritage that are at risk of destruction or irreparable damage. Over 300 places have been listed in its 32-year history, and in that time, fewer than 5 percent of listed sites have been lost. The 2019 list includes a diverse mix of historic places across America that face a range of challenges and threats, from climate change to inappropriate development to neglect and disuse. Find out what you can do to support these irreplaceable sites through the list below.'



Mike Renner

### Bismarck-Mandan Rail Bridge

Bismarck, North Dakota

ADD YOUR NAME

The Bismarck-Mandan Rail Bridge connects Bismarck and Mandan, North Dakota. Constructed in 1883, it was the first rail bridge built across the upper Missouri River. The iconic bridge has been recognized as an International Site of Conscience for the role it played in opening the western United States to white settlement—and the resulting profound impacts to Native American communities—but it has been proposed for demolition by railway company BNSF.

The Coast Guard is in consultation with BNSF and other parties under Section 106 of the National Historic Preservation Act. The Coast Guard has proposed a conditional permit that would require BNSF to retain the historic bridge until after an adjacent new bridge is constructed, in order to allow time to identify a preservation solution for the Bismarck-Mandan Rail Bridge. Tell the Coast Guard not to allow demolition of this iconic bridge.



**National Trust for Historic Preservation**  
*Save the past. Enrich the future.™*

**APPENDIX H** Public Input

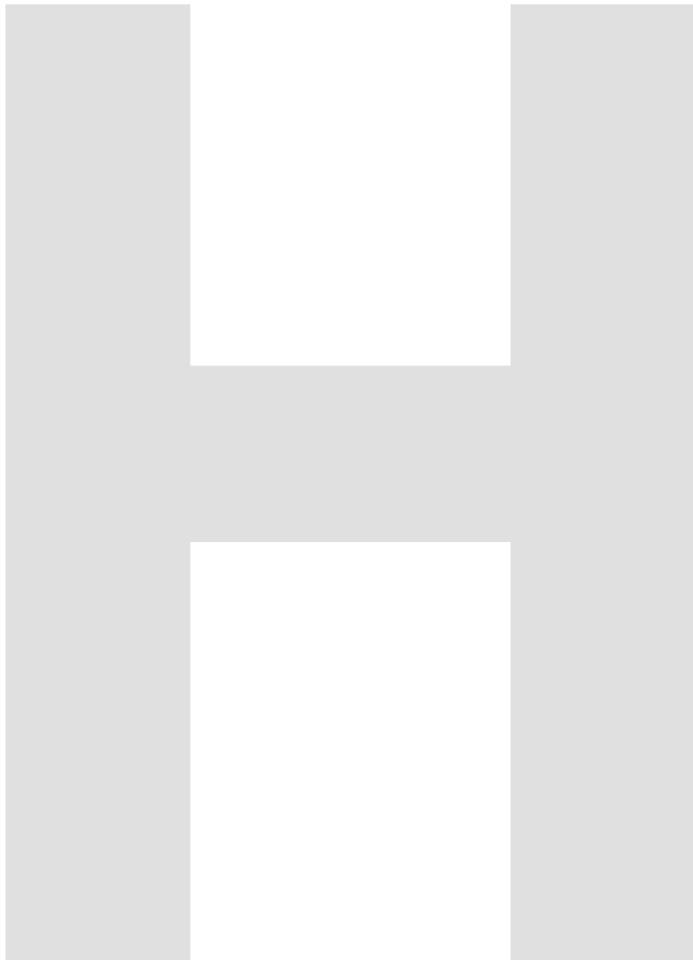

When we see the Brooklyn Bridge or the Golden Gate Bridge we recognize them for their place in history, as wonders of technology, as icons of a place - a time past and present. When we look at this Rail Bridge, **in our own backyard**- it is as nationally and regionally significant for what it represents. The 60 miles of the Missouri River around Bismarck-Mandan, between the Garrison and Oahe dams, is host to a National Heritage Area, national historic sites, numerous state historic sites and parks, and recreational trails. The Rail Bridge is an integral piece to the history and experience of this region.

Spanning the Missouri River in 1883 this bridge was completed the same year as the Brooklyn Bridge. No one would think of tearing down that bridge.

When traveling- visitors want to experience the icons of a special place - in Paris, for many visitors, it is the iconic Eiffel Tower. I feel that the Rail Bridge is our Eiffel Tower- immediately recognizable and representative of a special place. BTW- this bridge is 6 years older than the Eiffel Tower. (built in 1889)

In an age of all most everything being disposable, our grandparents and great grandparents who lived through the Depression and our children today recognize the value of recycling or repurposing what we have. This bridge should not be thought of as disposable.

We must respect the past, repurpose in the present and build for the future-

A new bridge is welcome, but we should also recognize the value of and potential for the Rail Bridge in the decades to come.

The Rail Bridge, for Bismarck-Mandan, North Dakota and the Missouri River, is part of our heritage. This Place Matters!



Commander  
Eighth Coast Guard District

1222 Spruce Street  
St. Louis, MO 63103-2832  
Staff Symbol: dwb  
Phone: (314) 269-2378  
Email: Eric.Washburn@uscg.mil

April 17, 2019

PUBLIC NOTICE D8 DWB-887

All interested parties are notified that an application dated April 19, 2019, has been received from the Burlington Northern Santa Fe Railway Company by the Commander, Eighth Coast Guard District, for approval of location and plans for the construction of a fixed railroad bridge over a navigable waterway of the United States.

WATERWAY AND LOCATION: Missouri River, Mile 336.2, at Sibley, between Jackson and Ray Counties, Missouri.

CHARACTER OF WORK: Construct a new fixed railroad bridge adjacent to and immediately downstream from the existing railroad bridge.

MINIMUM NAVIGATIONAL CLEARANCES:

<u>Existing</u>	<u>Proposed</u>
Horizontal: 383.0 feet at channel margins measured normal to flow of river	Horizontal: 375.0 feet at channel margins measured normal to flow of river
Vertical: 88.5 feet above zero on Napoleon W.B. gage at mile 328.6	Vertical: 89.1 feet above zero on Napoleon W.B. gage at mile 328.6

ENVIRONMENTAL CONSIDERATIONS:

The Coast Guard, the lead federal agency, has made a tentative determination that the companion bridge is categorical exclusion for the purposes of the National Environmental Policy Act (NEPA) because it satisfies criteria for such actions listed in the Coast Guard's NEPA Implementing Instructions. The applicant performed a Cultural Resources Survey for the proposed bridge project during the environmental review process.

The applicant determined that the proposed project will have no adverse impacts to cultural resources listed or eligible for listing in the National Register of Historic Places, or otherwise of archaeological, historical, or architectural significance. The Missouri State Historic Preservation Office (MoSHPO) concurred with this determination on August 22, 2017 and subsequently on December 14, 2018. The bridge is located in the base floodplain. The 100-year flood elevation is 714.4 feet m.s.l., while elevation of the low steel of the navigation span is 771.78, elevations are referenced to NAVD88 datum. No excavated material nor permanent fill material will be placed below the 100-year flood elevation. Approximately 0.26 acres of permanent wetlands will be impacted by the project and 0.86 acres of temporary wetlands will be impacted. These wetlands will be mitigated at Clear Fork Mitigation Bank. Water Quality Certifications (WQC) pursuant to Section 401 of the Clean Water Act have been applied for from the State of Missouri, Department of Natural Resources. The project will have no impacts on historic properties, threatened or endangered species,

residential and business properties, minority and low-income populations, or adversely impact Environment Justice.

The Coast Guard has made the determination that the proposed project will not pose a risk to Federally-listed threatened and endangered species. The applicant, as the Coast Guard's designated Federal representative, coordinated with the U.S. Fish and Wildlife Service (USFWS), which concurred on October 11, 2017, that "[t]his project is not likely to adversely affect any species under the Endangered Species Act, as amended."

The environmental document is available for review at the office of the Commander (dwb), Eighth Coast Guard District, Bridge Branch, Room 2.102D, 1222 Spruce Street, St. Louis, Missouri 63103-2832, Monday through Friday, 8:00 a.m. to 4:00 p.m., except Federal holidays.

**SOLICITATION OF COMMENTS:**

Interested parties are requested to express their views, in writing, on the proposed bridge. Give sufficient details to establish a clear understanding of the reasons for support or opposition to the proposal. Comments will be received for the record at the office of the Commander (dwb), Eighth Coast Guard District Bridge Branch, Room 2.102D, 1222 Spruce Street, St. Louis, Missouri 63103-2832 through May 20, 2019. Any comments received will be made part of the case record.

Location map and plans are attached.

//s//  
ERIC A. WASHBURN  
Bridge Administrator, Western Rivers  
By direction of the District Commander

NOTE: The mailing list for this Public Notice is arranged by watershed. Due to the size of this list, selective mailing is not practical. Please discard notices that are not of interest to you. If you have no need for any of these notices, please advise us so that your name can be removed from the mailing list.

POSTMASTER: Official business. Please post.

"This is a web-searchable copy and is not the official, signed version; however, other than the signature being omitted, it is a duplicate of the official version."

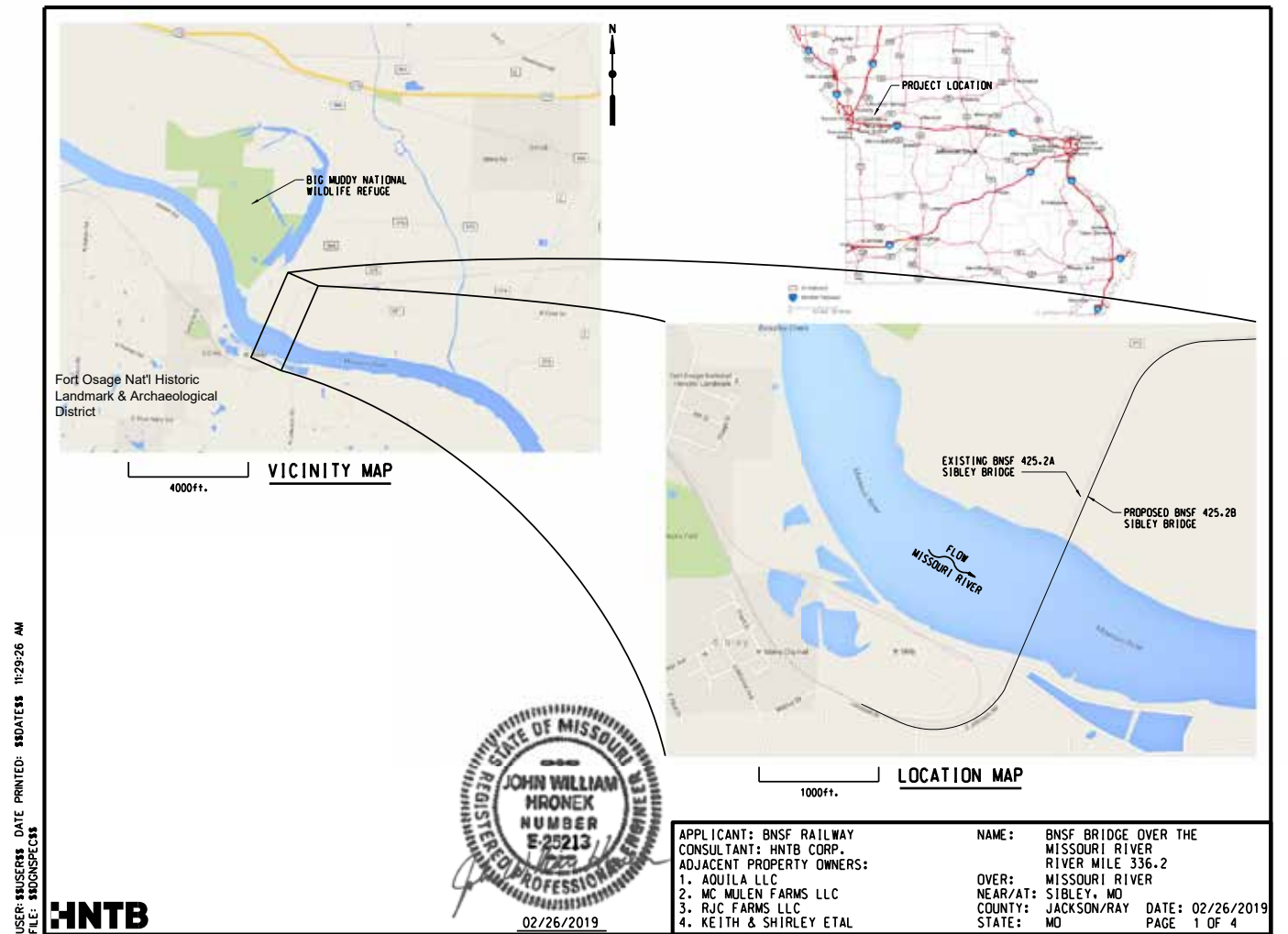

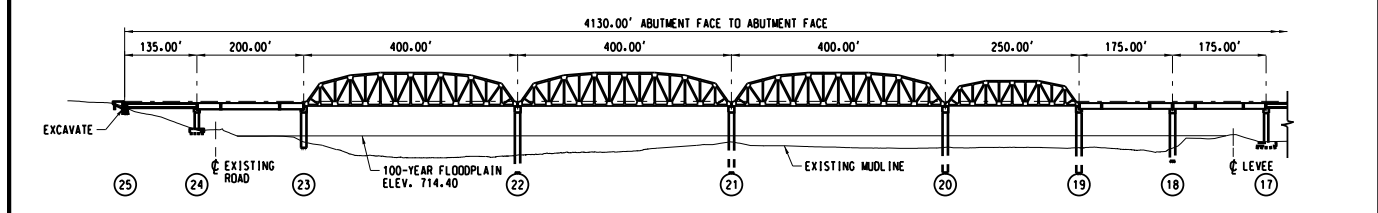
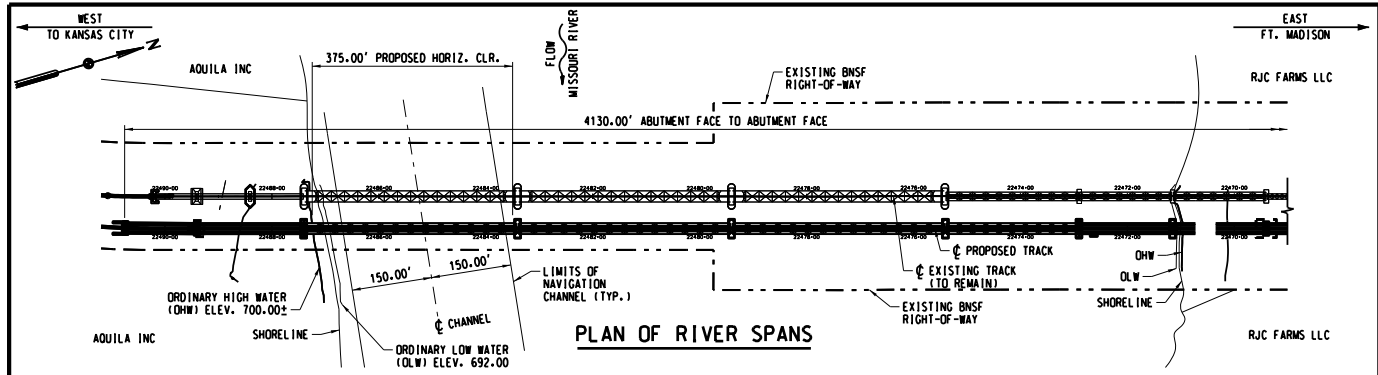

NOTE:  
NO EXCAVATED MATERIAL NOR PERMANENT FILL MATERIAL WILL BE PLACED BELOW THE 100-YEAR FLOOD CONTOURS.

NOTES:  
1. EXISTING BRIDGE TO REMAIN IN PLACE.  
2. SINGLE TRACK RAILROAD BRIDGE.  
3. DIMENSIONS SHOWN ARE IN FEET.  
4. SURVEY DATUM:  
HORIZONTAL: NAD83 STATE PLANE MO WEST  
VERTICAL: NAVD83

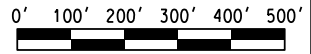
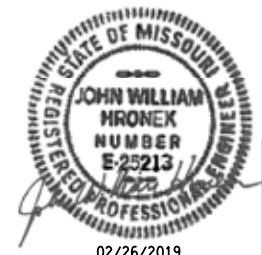

APPLICANT: BNSF RAILWAY  
CONSULTANT: HNTB CORP.  
ADJACENT PROPERTY OWNERS:  
1. AQUILA LLC  
2. MC MULLEN FARMS LLC  
3. RJC FARMS LLC  
4. KEITH & SHIRLEY ETAL

NAME: BNSF BRIDGE OVER THE MISSOURI RIVER  
RIVER MILE 336.2  
OVER: MISSOURI RIVER  
NEAR/AT: SIBLEY, MO  
COUNTY: JACKSON/RAY  
STATE: MO

DATE: 02/26/2019  
PAGE 2 OF 4

USER: BUSER88 DATE PRINTED: 8/26/2019 11:30:10 AM FILE: 8/26/2019

HNTB

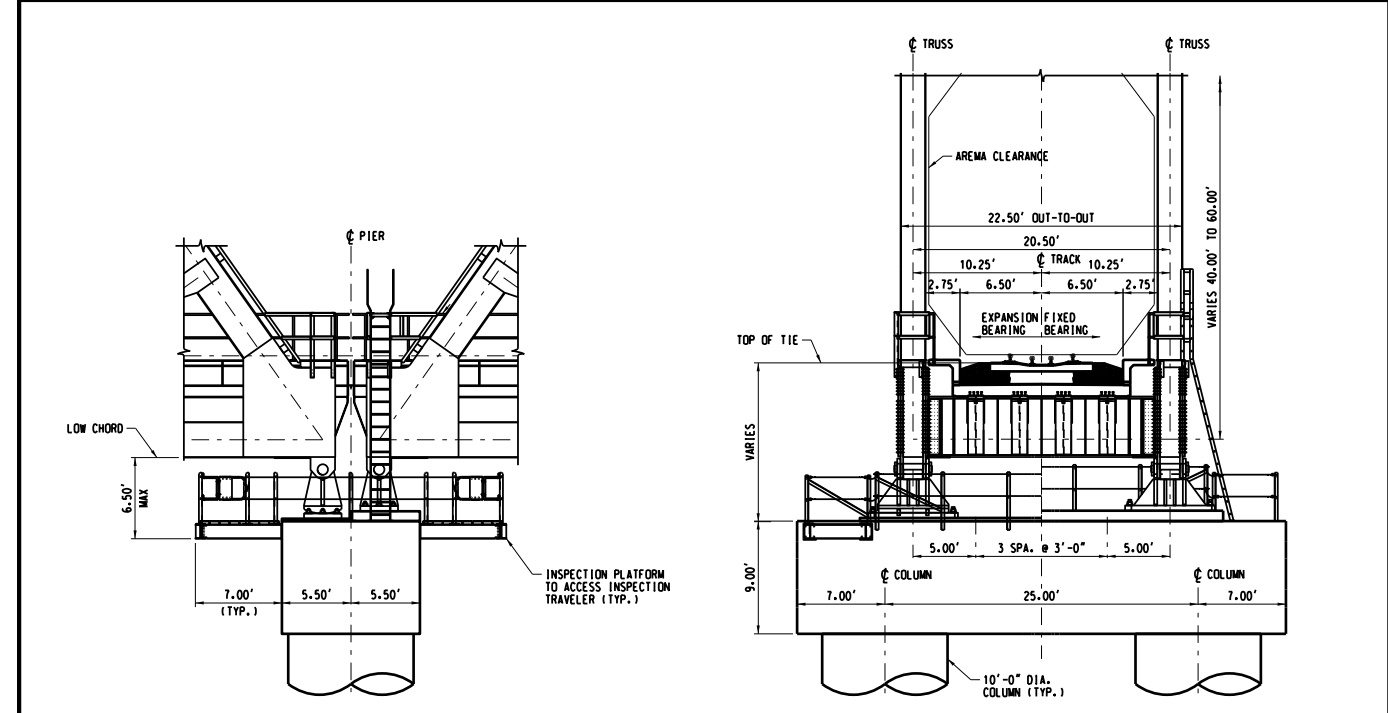

NOTES:  
1. DIMENSIONS SHOWN ARE IN FEET.

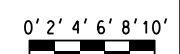

APPLICANT: BNSF RAILWAY  
CONSULTANT: HNTB CORP.  
ADJACENT PROPERTY OWNERS:  
1. AQUILA LLC  
2. MC MULLEN FARMS LLC  
3. RJC FARMS LLC  
4. KEITH & SHIRLEY ETAL

NAME: BNSF BRIDGE OVER THE MISSOURI RIVER  
RIVER MILE 336.2  
OVER: MISSOURI RIVER  
NEAR/AT: SIBLEY, MO  
COUNTY: JACKSON/RAY  
STATE: MO

DATE: 02/26/2019  
PAGE 4 OF 4

USER: BUSER88 DATE PRINTED: 8/26/2019 11:48:01 AM FILE: 8/26/2019

HNTB

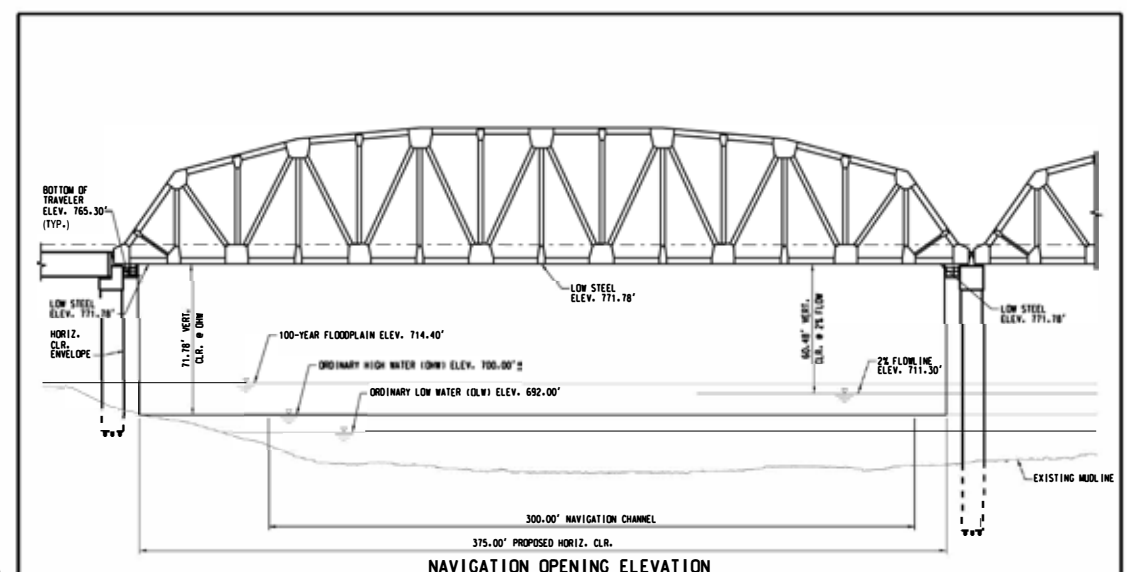

NOTE:  
NO EXCAVATED MATERIAL NOR PERMANENT FILL MATERIAL WILL BE PLACED BELOW THE 100-YEAR FLOOD CONTOURS.

NOTES:  
1. EXISTING BRIDGE TO REMAIN IN PLACE.  
2. SINGLE TRACK RAILROAD BRIDGE.  
3. DIMENSIONS SHOWN ARE IN FEET.  
4. SURVEY DATUM:  
HORIZONTAL: NAD83 STATE PLANE MO WEST  
VERTICAL: NAVD83  
5. TRAVELER SYSTEM TO BE STORED ADJACENT TO PIER WHEN NOT IN USE.

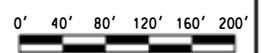

APPLICANT: BNSF RAILWAY  
CONSULTANT: HNTB CORP.  
ADJACENT PROPERTY OWNERS:  
1. AQUILA LLC  
2. MC MULLEN FARMS LLC  
3. RJC FARMS LLC  
4. KEITH & SHIRLEY ETAL

NAME: BNSF BRIDGE OVER THE MISSOURI RIVER  
RIVER MILE 336.2  
OVER: MISSOURI RIVER  
NEAR/AT: SIBLEY, MO  
COUNTY: JACKSON/RAY  
STATE: MO

DATE: 02/26/2019  
PAGE 3 OF 4

USER: BUSER88 DATE PRINTED: 8/26/2019 11:30:10 AM FILE: 8/26/2019

HNTB



Midtown Greenway Extension across Mississippi River  
Bridge L5733  
Pedestrian/Bicycle Trail Use Study



*Feasibility Report*

Prepared for:  
Midtown Greenway Coalition

April 12, 2019

FEASIBILITY REPORT  
FOR  
MIDTOWN GREENWAY COALITION  
GREENWAY EXTENSION OVER MISSISSIPPI RIVER  
BRIDGE L5733  
PEDESTRIAN/BICYCLE TRAIL USE STUDY



Kimley-Horn and Associates, Inc.  
767 Eustis Street  
Suite 100  
St. Paul, MN 55114  
(651)-645-4197

I hereby certify that this plan, specification, or report was prepared by me or under my direct supervision and that I am a duly Registered Professional Engineer under the laws of the State of Minnesota.

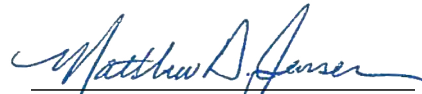
  
Matthew D. Jensen

April 12, 2019 License No. 44587

**MIDTOWN GREENWAY COALITION  
SHORT LINE BRIDGE - BRIDGE L5733  
MIDTOWN GREENWAY EXTENSION ACROSS MISSISSIPPI RIVER  
PEDESTRIAN/BICYCLE USE STUDY FEASIBILITY REPORT**

**TABLE OF CONTENTS**

1. INTRODUCTION .....	2
2. OBSERVED CONDITIONS .....	3
3. PROPOSED IMPROVEMENT ALTERNATIVES .....	9
4. ENVIRONMENTAL DOCUMENTATION .....	14
5. ESTIMATED COSTS FOR ALTERNATIVES .....	14
6. PROJECT SCHEDULE .....	16
7. DISCLAIMER .....	16

APPENDIX A – LOCATION MAP

Figure A1: Location Map

APPENDIX B – SITE PHOTOS

Exhibit B1-B10: Site Photos

APPENDIX C – BRIDGE GEOMETRY

Exhibit C1: Bridge Elevation and Fracture Critical Members

APPENDIX D – COST & SUMMARY EXHIBITS

Exhibit D1-D5: Pre-Design Opinion of Probable Costs Details  
Exhibit D6: Alternative Consideration Summary

**MIDTOWN GREENWAY COALITION  
SHORT LINE BRIDGE - BRIDGE L5733  
MIDTOWN GREENWAY EXTENSION ACROSS MISSISSIPPI RIVER  
PEDESTRIAN/BICYCLE USE STUDY FEASIBILITY REPORT**

*EXECUTIVE SUMMARY*

This Feasibility Report has been prepared for the Midtown Greenway Coalition (MGC) to evaluate the potential multi-use trail connection from the eastern end of the Midtown Greenway at West River Parkway eastward across the Mississippi River on the existing Short Line Bridge (Bridge L5733) as a regional connection to points east including the University of Minnesota, Allianz Field, and downtown St. Paul.

Bridge L5733 crosses the Mississippi River between Franklin Avenue and Lake Street in the City of Minneapolis. The existing bridge was constructed in 1902 by the Chicago, Milwaukee, St. Paul and Pacific Railroad. The bridge is currently owned by Canadian Pacific Railway which leases railroad operations to the Minnesota Commercial Railroad as an industrial spur line to South Minneapolis. The bridge is composed of three segments; the west approach over West River Parkway, the three main truss spans over the Mississippi River, and the east approach over East River Road.

The project included due diligence and information gathering about the bridge, two site visits of Bridge L5733 to determine the existing bridge geometry, condition, and to identify recommended improvements for converting or adding a pedestrian and bicycle facility to the structure.

The condition of the entire bridge was observed, and conditions were documented to determine the required improvements to facilitate partial or total use as a pedestrian and bicycle facility. Other components were evaluated based upon visual observations and previous inspection information provided by the Minnesota Department of Transportation (MnDOT).

Four alternatives are being considered to provide a shared use trail on the bridge:

1. Freight railroad ceases to operate. Bridge is converted to shared use trail.
2. Freight railroad continues to operate. Existing bridge rehabilitated. Shared use trail added.
3. Freight railroad continues to operate. Existing bridge partially reconstructed. Shared use trail added.
4. Freight railroad continues to operate. Supplemental structure with shared use trail added above existing bridge

A cost estimate was developed for the alternatives considered to facilitate the desired use.

Financing or funding sources have not been secured beyond the fundraising used to provide this study. One intention of this study is to provide information needed to solicit funding for the desired improvements. It is not known what environmental documentation process may be required or the permits and approvals that may be needed to allow this project to proceed. Any future construction activities will need to be coordinated with the current or future owner of the bridge.

The improvements to Bridge L5733 are included as a part of this project are detailed in this report along with estimated costs. The estimated project costs include a contingency allowance and estimates for indirect costs such as engineering, permitting, and construction phase services.

# 1. INTRODUCTION

On June 15, 2018, the Midtown Greenway Coalition (“MGC” or “Client”) authorized the preparation of a feasibility report for the Short Line Bridge (Bridge L5733) over the Mississippi River in Minneapolis, Minnesota. This Feasibility Report has been prepared for the Client’s use to understand feasibility to add a shared use trail to the existing bridge and associated costs. The project includes conducting one site visit for drone imaging support, one structural site visit, and providing a discussion of feasibility and associated opinion of costs to add a shared use trail (bicycle & pedestrian use) to the existing railroad bridge. A project location map and site photos are provided in Appendix A and Appendix B.

A previous study of extending the Midtown Greenway over the Mississippi River was completed in September 2006 for Hennepin County by URS Corporation. This report considered several options to cross the river, including the use of the existing Short Line Bridge and new bridges on new alignments adjacent to the existing railroad bridge. The report explores reuse of the existing railroad bridge but recommends not considering reuse of the existing bridge due to “...long-term maintenance, railroad easement/lease costs, railroad operational liability, structural integrity (Pin Connected Eye Bar), structural compatibility (modern vs. 125 yr old) and fire risk issues.” This report acknowledges these concerns, however since 2006 there have been significant developments in understanding and mitigation of structural concerns on fracture critical bridges.

The Twin Cities area has several examples of pin connected truss bridges carrying pedestrians:

- Boom Island Railroad Bridge
- Northern Pacific Railroad Bridge No. 9
- Hanover Bridge

This report provides four alternatives that could consider reuse of all or parts of the existing bridge and mitigates the structural integrity risk by providing structural redundancy of the existing truss.

The MGC is exploring the feasibility to add pedestrian and bicycle use to Bridge L5733 to allow regional trail connectivity to other existing and proposed trail corridors east of the Mississippi River. Bridge L5733 was originally constructed in 1902 by the Chicago, Milwaukee, St. Paul and Pacific Railroad (Milwaukee Road) and is currently owned by Canadian Pacific Railway (CP Rail) which leases railroad operations to the Minnesota Commercial Railroad as an industrial spur line to businesses in South Minneapolis. The railroad typically operates one train per day over the structure.

The bridge is composed of three superstructure units shown below in Table 1.

<b>Unit of Bridge L5733</b>	<b>Length (feet)*</b>	<b>Superstructure Type</b>
West Approach (Span 1 over W River Pkwy)	72	Steel Plate Girders
Main Truss (Spans 2-4 over Mississippi River)	843	Steel Deck Truss
East Approach (Span 5-6 over E River Rd)	162	Steel Plate Girders

**Table 1: Superstructure Units**

\* Bridge geometry determined from LiDAR data

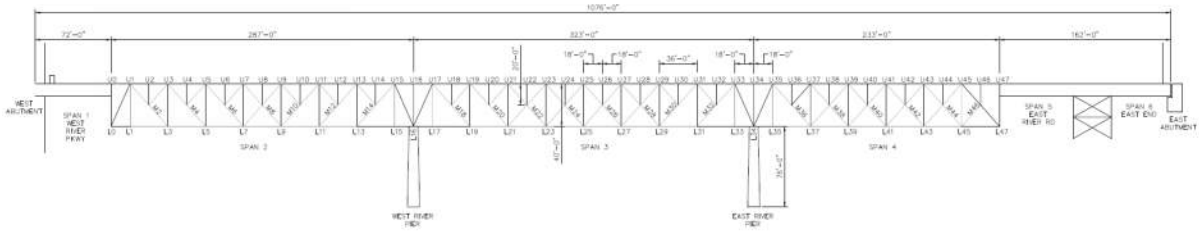

Figure 1: Overall Bridge Elevation looking North (See Appendix C1 for larger view)



Figure 2: Project Location

Bridge L5733 has one west approach deck girder span (Span 1), three deck truss spans over the main river gorge (Spans 2-4), and two east approach deck girder spans (Spans 5-6) for a total bridge length of 1076 feet long.

## 2. OBSERVED CONDITIONS

The bridge owner would not permit direct access to the bridge. In addition, no plans have been made available for the bridge. During the planning for this study, a new technology was identified to provide information on the bridge geometry, condition, and imagery that would provide a baseline to understand observed condition of the bridge. The new technology implemented was an Unmanned Aircraft System, or Drone, with LiDAR and photo imagery capabilities. The LiDAR information provides the geometry of the in-place bridge and the still imagery provides information on the existing condition.

The MGC hired Performance Drone Services (PDS) of Edina, MN to conduct the Aerial LiDAR Acquisition & Post Processing, and the aerial media and still imagery of Bridge L5733. The aerial LiDAR acquisition was completed on July 18, 2018. After the raw data was processed, this information was provided September 28, 2018. This information was viewed and discussed by the engineering team and formed the basis to document the condition of the bridge.

A structural site visit was completed on October 4, 2018, to review the condition of Bridge L5733. Access to the site via the east and west banks of the Mississippi and East River Road and West River Parkway. The railroad has security gates installed at each end of the bridge that are remotely controlled to provide railroad access across the structure.

The bridge cross section consists of an open deck floor system supporting one track. The original bridge had two tracks, but the south track has been removed and a walkway and cable railing has been installed on the south side and adjacent to the existing track.

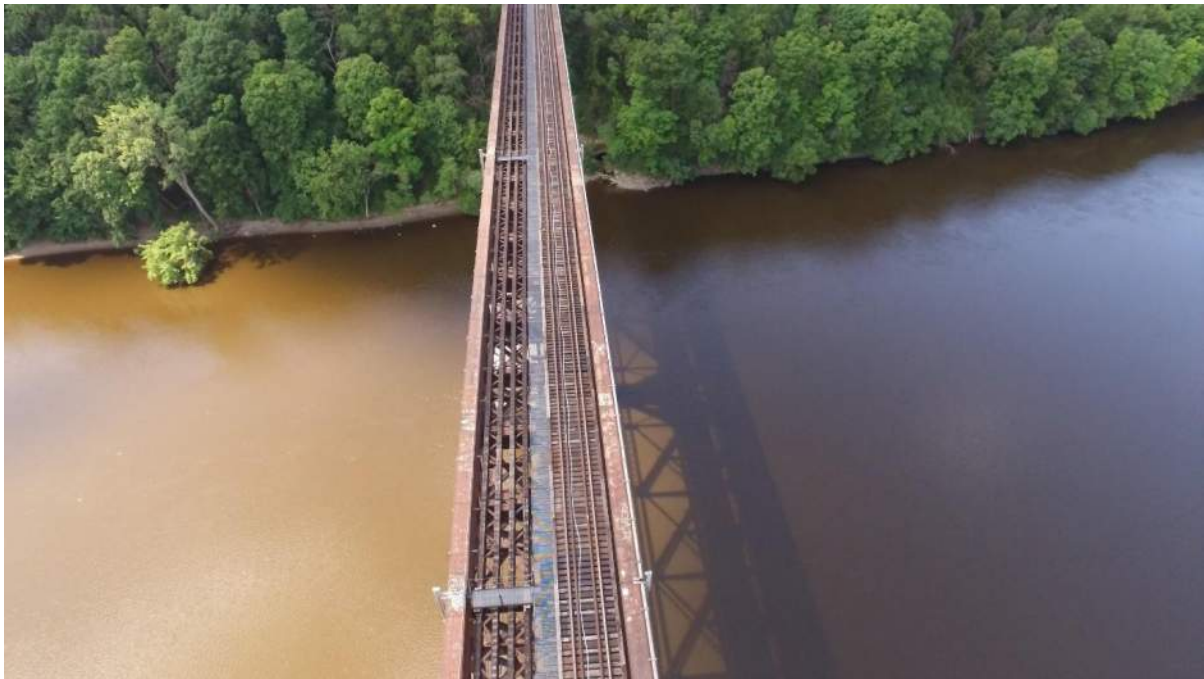

**Figure 3: Top Section view looking from above towards the west river bank**

### **West Approach (Span 1)**

The west approach, Span 1, of Bridge L5733 consists of one span deck plate girder span supported by the cast-in-place concrete west abutment and a steel pier supported to the same elevation as the L0 panel point of the main truss span. A large concrete retaining wall supports the West River Parkway and trail embankment.

The superstructure consists of two deck plate girders, six floor beams, and eight stringers. All superstructure metal components have full paint system loss and heavy corrosion. No significant section loss was observed, but localized section loss is identified in the bridge inspection report.

The substructure consists of the west abutment and the steel pier. The abutment concrete is in good to fair condition, with some cracking and evidence of seepage on the backwall. The bearing areas appear sound. The steel pier supporting the east end of Span 1 in similar condition to the Span 1 superstructure. The foundation for the steel pier was not visible.



Figure 4: West Approach, Span 1 looking south

### **Main Truss (Spans 2-4 over Mississippi River Gorge)**

The main truss spans over the Mississippi River Gorge consist of three Baltimore deck truss spans, with a floor system and stringers supporting the railroad track and floor decking system. The trusses are supported at each river bank on concrete foundations as well as two masonry piers within the river.

#### ***Steel Truss Members***

The trusses are a type of Pratt truss that provide additional bracing to the compression members (top chord with a deck truss) that help the compression members resist buckling and help to control deflection. For Bridge L5733, the top chord and vertical members are typically in compression, while the bottom chord and diagonals (except near supports) are in tension.

Tension members in a truss bridge are considered “Fracture Critical Members” (FCM). The current National Bridge Inspection Standards (NBIS) definition for a FCM is "a steel member in tension, or with a tension element, whose failure would probably cause a portion of or the entire bridge to collapse." The FCM on the truss spans are primarily eyebars

connected to adjacent members with steel pins, which is a typical practice from the era this bridge was constructed.

FCM elements require detailed ultrasonic inspection to monitor and verify the viability of these components. As this is a railroad bridge, it is not known if the FCMs on Bridge L5733 have had in-depth inspection of these elements in the past. This report has not identified any required repairs. Future inspections will be required to identify the specific condition and monitor the condition of these elements.

The trusses are 40-ft deep and have a typical 36-ft spacing between the main panel points.



**Figure 5: Main Truss Spans 2-4 over River looking North**

The following figure provides the FCM for Bridge L5733, which is also provided in Appendix C1 at a larger scale.

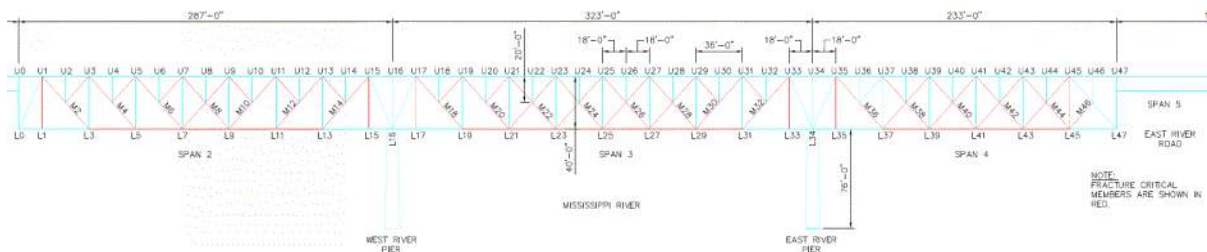

**Figure 6: Fracture Critical Members (See Appendix C1 for larger view)**

The Main Truss Unit was visually observed from the ground level only and through the imagery provided by the UAS flight. In general, the main truss is in fair condition. Tension members consist 2 to 8 individual eyebars per member, and compression members are built up members consisting of plate, channels, angles, batten plates and lacing plates connected by rivets. There is full paint system failure, scale and corrosion prevalent across the trusses,

pack rust, and spot section loss that is likely reducing the overall capacity of the truss spans. Based upon the observed condition to these members, this report assumes that repairs will be required to restore the required capacity.

### ***Truss Floor System***

All floor system elements were reviewed as was available via binoculars from the river banks. The floor system consists of 8 stringers (4 per track) supported by floor beams connected to the trusses at each panel point. The paint system is compromised throughout the bridge floor system, but minimal section loss is assumed due to the lack of chlorides used on railroads. Minimum steel strengthening improvements are assumed to be required and are included in the repair scope of work. Based upon visual site observations, this report assumes the no major structural improvements will be required to the truss floor system.

### ***Truss Substructures***

The truss spans are founded on Piers located at Panel Point L0, L16, L34, and L47. The piers at L0 and L47 concrete foundations located near the lower chord at the top of the river bluffs on each side of the Mississippi River. The western bluff pier footing was not visible, as they were covered by accumulated debris around the truss bearings. The eastern bluff pier footing is cast-in-place concrete with minor spalling and deterioration.

The two river piers are masonry wall piers with cast-in-place concrete caps. According to the most recent underwater inspection report for Bridge L5733, the river piers are in good condition with no significant defects. The stone masonry was in good condition. No vertical footing exposure was observed in the river channel. The channel bottom appeared stable with no significant scour observed and with minimal changes since the last inspection. No action to mitigate this local scour is included in the improvements. The piers visually are in good condition and no improvements are recommended.

This report assumes no improvements are required to the truss substructures.

### ***Other components***

The truss has other important components that were visually inspected that this report assumes no improvements will be required. These include the following:

- Truss lateral bracing below the floor system
- Truss lateral bracing at the lower chord
- Truss sway bracing at each panel point

### **East Approach (Span 5 & 6)**

The east approach, Spans 5 and 6 of Bridge L5733, consists of two deck plate girder trestle spans supported by a steel pier supported to the same elevation as the L47 eastern end of the main truss span, a steel trestle pier and the cast-in-place concrete east abutment.

The Span 5 and 6 superstructure consists of two deck plate girders, six floor beams, and eight stringers, similar to the West Approach. All superstructure metal components have full paint system loss and heavy corrosion. No significant section loss was observed, but localized section loss is identified in the bridge inspection report. There are some deformed members at the east abutment due to direct loading of the ends of the plate girders from the backwall of the east abutment.



**Figure 7: Span 5 looking north over East River Road, Span 6 obscured by vegetation**

The substructure consists of the two-column steel pier near L47, the four-column trestle pier, and the east abutment. The abutment concrete is in fair to poor condition due to the issues with the backwall pressure on the superstructure and evidence of seepage on the backwall. The bearing areas appear sound. The steel piers supporting the west end of Span 5 is in similar condition to the Span 5 and 6 superstructure. The foundation for the steel pier was not visible.

### **Existing Bridge Capacity Commentary**

Railroad bridges over public right of ways are not required to be load rated by the Minnesota Department of Transportation (MnDOT), therefore no load rating information is available from MnDOT. The Federal Railroad Administration requires a bridge owner's railroad engineer to verify the capacity of the bridge is greater than the loads operated on a bridge.

The bridge owner has chosen not to provide any information regarding the bridge, therefore this study can only assume that the existing bridge capacity is sufficient for the railroad loads operated upon the bridge. Currently the bridge supports one freight railroad track. The freight railroad load is greater than the desired shared use trail, assuming the freight railroad no longer operates on the bridge.

For other alternatives that have shared use of the bridge with freight railroad and bicycle/pedestrian facilities, this study assumes strengthening of the bridge would be required. These improvements are described in Section 3. This report also identifies detailed structural inspection and structural analysis in later phases of the project to retire the risks assumed within this study.

### 3. PROPOSED IMPROVEMENT ALTERNATIVES

The goal of the MGC is to facilitate extension of the current Midtown Greenway across the Mississippi River on Bridge L5733. There are four alternatives that are being considered to provide a shared use trail on the bridge:

1. Freight railroad ceases to operate. Bridge is converted to shared use trail.
2. Freight railroad continues to operate. Existing bridge rehabilitated. Shared use trail added.
3. Freight railroad continues to operate. Existing bridge partially reconstructed. Shared use trail added.
4. Freight railroad continues to operate. Supplemental structure with shared use trail added above existing bridge

#### *Consistent Alternative Parameters*

To be consistent with comparisons across these alternatives, the following parameters are held constant across all alternatives:

- Shared use trail (bicycle & pedestrian use facility) is the desired use.
- Deck width is twelve feet, the standard bridge width for bicycle/pedestrian facilities.
- Decking material is a lightweight aluminum planking that permits water to flow through the deck and minimizes loading on the bridge.
- Bridge railings are 10-ft tall code compliant metal railings for railroad separation and to mitigate access to non-permitted areas on the bridge (deter climbing).
- Bridge railings are 4.5-ft tall code compliant metal railings for fall protection where railroad protection is not required.
- Off-bridge improvements are generally not included unless specifically identified.
- Bridge lighting is provided. (trail lighting only, no aesthetic lighting)
- Signage or trail wayfinding or emergency telephones are located off the bridge.
- Planters and/or benches are not assumed to be provided on the bridge.
- No separation curbs/barriers/protection between bicycles and pedestrian.
- Existing bridge painting is not included.
- At each end of the bridge, bollards will limit vehicles from accessing the bridge.
- Emergency or maintenance vehicles are permitted through controlled access.
- Accumulated snow is assumed to be cleared with the design maintenance vehicle.
- No preventative or long-term maintenance activities or costs are included.

During project development, some or all of these assumptions can be revised or adapted based upon the desired use and functionality of the bridge. Parameter changes will have a direct impact on project costs.

#### *Structural Inspection and Structural Analysis Assumption*

All alternatives will require a structural inspection and structural analysis to understand the inherent existing bridge load capacity and demand based upon the intended use for each alternative. This study assumes a full structural inspection will be provided as the project is developed to confirm existing bridge conditions, as they will likely deteriorate from the work of this study, and identify all bridge defects and section loss used to model the actual condition of the bridge. These defects will be used in the structural analysis to determine the

modeled bridge load capacity and the modifications necessary to provide for each alternative intended use.

### ***Bridge Redundancy and Risk Assumption***

This existing bridge is considered “Fracture Critical”, meaning the bridge does not inherently have enough redundancy to resist total collapse if a fracture critical member of the bridge fails. For Bridge L5733 the FCMs are the eyebars and pins found throughout the structure. Future owners of the bridge may not choose to accept a structure with this level of risk, and therefore bridge improvements may be required to provide adequate redundancy to mitigate this risk. This report will provide some level of analysis for each option on how to provide a redundant structure to mitigate this risk for a potential future owner.

### **Proposed Improvements for Alternatives**

The following is a description of the proposed improvements considered to provide Bridge L5733 to allow pedestrian and bicycle use. The following items describe the proposed improvements and assumptions for each alternative. The scope of this study did not provide for project graphics, or illustrations of the following alternatives. Graphics shown were provided by the client.

#### ***Alternative 1: Cease Freight Rail Operation, Convert to Shared Use Trail***

This alternative considers that CP Rail ceases railroad operation across the bridge and abandon the existing railroad right of way. The timing of this scenario is unknown and may not be on the near-term horizon.

##### **A. Shared Use (Bicycle and Pedestrian) Trail Layout**

The bridge deck would be placed on the structure to maximize the load distribution to the bridge. This would likely be centered on one of the two existing track alignments on the north or south side of the bridge width.

##### **B. Safety**

4.5-ft tall metal railings would be provided along the edge of deck for the length of the bridge, with access to the river navigational beacons as required.

##### **C. Trail Connectivity**

The existing Midtown Greenway could directly connect to the west end of the bridge with minimal grade change. At the east end of the bridge, the trail could connect directly to the existing railroad grade.

##### **D. Railroad Agreements**

This study is not able to speak to the acquisition of the railroad right-of-way, but acknowledges that some level of effort will be required to acquire the right of way for the bridge.

##### **E. Bridge Redundancy and Risk Mitigation Strategy**

For the bridge to be considered redundant, a strategy to provide internal redundancy must be developed to mitigate the risk of FCM failure and bridge collapse. One strategy that may be considered would be to provide redundant tension members adjacent to the existing eyebars and redundant load transfer

mechanisms at the pin connectors. This study assumes a base-line cost to develop and design the redundancy strategy, and a construction cost to implement.

The 12-ft shared use trail live loading is significantly less than the original two track freight railroad loading. A structural inspection and structural analysis will be required to understand the inherent bridge load capacity and demand based upon the intended use. This study assumes these inspection and analysis is provided as the project develops and carries a cost for these efforts.

F. Aesthetic, historical, and viewshed impacts

This alternative has no significant negative aesthetic, historical, or viewshed impacts. Structural improvements are only those required for bridge load capacity and are not anticipated to affect bridge aesthetics or the historic fabric of the bridge. Users can experience unimpeded views to the north and south above the safety railing.

***Alternative 2: Rehabilitate Bridge to provide Freight Rail and Shared Use Trail***

This alternative considers that CP Rail continues railroad operation across the bridge and the existing bridge is rehabilitated to provide continued freight rail use with a shared use trail adjacent to the existing railroad track and railroad walkway separated by tall fence. This option is only feasible if the railroad can agree to permit the desired use on their right of way.

A. Shared Use (Bicycle and Pedestrian) Trail Layout

The bridge deck would be placed on south side of the bridge with the trail width potentially limited by the railroad's use of the existing bridge deck width. This alternative assumes the full 12-ft wide shared use trail section is provided and may need to extend past the south fascia of the bridge.

B. Safety

A 10-ft tall metal railing would be used between the trail and railroad for use separation along the length of bridge. A 4.5-ft tall metal railing would be provided along the south edge of deck for the length of the bridge, with access to the river navigational beacons as required.

C. Trail Connectivity

The existing Midtown Greenway could directly connect to the west end of the bridge with minimal grade change. At the east end of the bridge, the trail could connect directly to the existing railroad grade.

D. Railroad Agreements

This study is not able to comment to what agency or organization may advocate and convince the railroad to permit this joint use of their facility. There has been successful joint use of railroad bridges in the US, but most railroads have no interest in accepting additional cost, risk, or operational impacts.

E. Bridge Redundancy and Risk Mitigation Strategy

For the bridge to be considered redundant, a strategy to provide internal redundancy must be developed to mitigate the risk of FCM failure and bridge collapse. One strategy that may be considered would be to provide redundant tension members adjacent to the existing eyebars and redundant load transfer

mechanisms at the pin connectors. As compared to Alternative 1, due to the addition of the freight railroad load there will be significant additional efforts to provide this load trail redundancy. This study assumes an increased cost to develop and design the redundancy strategy, and a greater construction cost to implement.

F. Aesthetic, historical, and viewshed impacts

This alternative has negative aesthetic, historical, or viewshed impacts. The separation fence between the railroad and the trail will impact the visual aesthetics of the bridge and the viewshed to the north. Structural improvements are only those required for bridge load capacity and are not anticipated to affect bridge aesthetics or the historic fabric of the bridge.

***Alternative 3: Partially Reconstruct Bridge to provide Freight Rail and Shared Use Trail***

This alternative considers that CP Rail continues railroad operation across the bridge and the existing bridge is reconstructed on the existing river piers. This would provide a new bridge structure and railroad/trail use similar to Alternative 2, except on a new bridge. This alternative would provide continued freight rail use with a shared use trail adjacent to the existing railroad track and railroad walkway separated by tall fence. This alternative would reconstruct the bridge superstructure on the existing river piers and abutments. The new bridge superstructure could be reconstructed with a load trail redundant superstructure. This option is only feasible if the railroad can agree to permit the desired use on their right of way.

A. Shared Use (Bicycle and Pedestrian) Trail Layout

The bridge superstructure would be designed to provide adequate width for the railroad operations (track and walkway) and the desired 12-ft wide shared use trail.

B. Safety

A 10-ft tall metal railing would be used between the trail and railroad for use separation along the length of bridge. A 4.5-ft tall metal railing would be provided along the south edge of deck for the length of the bridge, with access to the river navigational beacons as required.

C. Trail Connectivity

The existing Midtown Greenway could directly connect to the west end of the bridge with minimal grade change. At the east end of the bridge, the trail could connect directly to the existing railroad grade.

D. Railroad Agreements

This study is not able to comment to what agency or organization may advocate and convince the railroad to permit this joint use of their facility. There has been successful joint use of railroad bridges in the US, but most railroads have no interest in accepting additional cost, risk, or operational impacts.

E. Bridge Redundancy and Risk Mitigation Strategy

The required redundancy would be provided in the new bridge superstructure.

F. Aesthetic, historical, and viewshed impacts

This alternative has potentially negative aesthetic, historical, or viewshed impacts. The reconstruction of the bridge superstructure could significantly affect bridge aesthetics and the historic fabric depending upon the selected superstructure type. The separation fence between the railroad and the trail will impact the visual aesthetics of the bridge and the viewshed to the north.

***Alternative 4: Provide supplemental structure above the existing bridge to provide Freight Rail and Shared Use Trail***

This alternative considers that CP Rail continues railroad operation across the bridge and a supplemental structure is added above the existing bridge to provide a new deck level for the shared use trail. This option is only feasible if the railroad can agree to permit the desired use on their right of way.



**Figure 8: Concept Graphic of Alternative 4 (Image provided by Dan Cross)**

A. Shared Use (Bicycle and Pedestrian) Trail Layout

The supplemental shared use trail bridge deck would be placed above the existing railroad deck to provide the minimum 23.5-ft of vertical clearance required. This alternative assumes a 12-ft wide trail, however the supplemental structure would likely need to be the full width of the existing bridge to facilitate load transfer effectively.

B. Safety

4.5-ft tall metal railings would be provided along the edge of the shared use trail deck for the length of the bridge. As the trail descends from above the railroad off the ends of the bridge, supplemental railroad separation fence would be required.

C. Trail Connectivity

With the shared use trail deck required to be about 27 feet above (accounting for the required structure depth), the connections to the existing grades would need to be addressed. Ramps extending down from this heighten level at each end of the bridge would be required sloping at or below code required maximum grades to touchdown with existing grades. Although this report does not include the cost of such connections, the approach configuration and slope requirements could be significant project costs that should be addressed if this alternative is advanced.

D. Railroad Agreements

This study is not able to comment to what agency or organization may advocate and convince the railroad to permit this joint use of their facility. There has been successful joint use of railroad bridges in the US, but most railroads have no interest in accepting additional cost, risk, or operational impacts.

E. Bridge Redundancy and Risk Mitigation Strategy

To provide redundancy to the bridge, the supplemental structure could be designed to provide the needed redundancy for all bridge loads, or coupled with improvements to the existing bridge redundancy described in Alternative 2A. This study assumes analysis and design costs for the supplemental structure and determination of how to provide a bridge with the overall required redundancy.

F. Aesthetic, historical, and viewshed impacts

Aesthetic and historical impacts could range from minimal to significant depending upon the type of supplemental structure to provide the elevated trail. Complementary structure types could be used to minimize these impacts. Users can experience unimpeded views to the north and south above the safety railing.

A summary of the four alternative considerations is provided in Appendix D, Exhibit D6: Alternative Consideration Summary.

#### **4. ENVIRONMENTAL DOCUMENTATION**

The project may require review by the Minnesota Department of Transportation, US Fish and Wildlife Service, National Park Service, Army Corp of Engineers and the Minnesota Natural Resources Commission as part of a NEPA environmental documentation process to achieve necessary approvals for the bridge improvements. The scope of the project and funding sources will determine the required reviews and documentation needed. It is important to understand the required environmental documentation process as this document will explore a no-build alternative and compare build alternatives to the purpose and need of the project.

#### **5. ESTIMATED COSTS FOR ALTERNATIVES**

The estimated costs for the proposed improvements described in the alternatives above for Bridge L5733 are detailed below. The estimated costs are based on current costs and will vary based on price escalation and market conditions.

	<i>Construction Cost Subtotal</i>	<i>Indirect Cost Subtotal</i>	<i>Contingency</i>	<b>Overall Cost</b>
Alternative 1: Cease Freight Rail Operation, Convert to Shared Use Trail	\$5,000,000	\$1,100,000	\$1,300,000	<b>\$7,400,000</b>
Alternative 2: Rehabilitate Bridge to provide Freight Rail and Shared Use Trail	\$6,800,000	\$1,400,000	\$1,700,000	<b>\$9,900,000</b>
Alternative 3: Partially Reconstruct Bridge to provide Freight Rail and Shared Use Trail	\$19,500,000	\$3,400,000	\$4,600,000	<b>\$27,500,000</b>
Alternative 4: Provide supplemental structure above the existing bridge to provide Freight Rail and Shared Use Trail	\$15,800,000	\$2,800,000	\$3,800,000	<b>\$22,400,000</b>

**Table 2: Opinion of Probable Costs**

Exhibits D1 through D4 in the Appendix provide detailed information regarding the Opinion of Probable Costs used to develop Table.

**Indirect Costs**

The proposed alternatives identified above are specific analysis, design, and construction tasks with associated costs. As stated, all alternatives will require additional inspection, rating and analysis, design, and construction effort to prepare construction documents describing the work above in detail to allow a contractor bidding process, which is assumed to be required based upon likely public funding. This report has identified certain costs for these items and provided relative costs associated with each task.

Inspection and Load Rating for Pedestrian Load is intended to identify the costs associated with an in-depth bridge inspection of the bridge and load rating of the bridge elements to confirm assumptions that have been made in this report. The in-depth inspection would require a two-person team and equipment to inspect and document the existing geometry, deterioration, and damage to the structure. This information would be used to provide a load rating analysis using the intended pedestrian loads to be carried by the bridge. This load rating analysis would confirm the members needing strengthening, or if a reduction in bridge width is needed to allow existing members to carry the intended loads.

Permitting and Agency Coordination is intended to identify the cost associated with gaining regulatory agency permits and coordination with these agencies to gain approvals for the improvements. These costs do not include any National Environmental Policy Act (NEPA) environmental documentation or approvals.

Design and Plan Preparation is intended to identify the costs associated with designing the alternatives being considered and developing plans for the required improvements for the alternative being considered. This information, along with other specifics of the bridge improvements identified above, would be included in construction documents provided to contractors to solicit bids for the improvement work.

Construction Phase Services is intended to identify the costs associated with construction administration, oversight, and inspections that may be desired or required during construction of the bridge improvements.

The estimated project costs include a 20 percent construction contingency and an allowance for indirect costs such as inspection, engineering and construction administration. All costs in the report are in today's dollars, not including possible escalation in the construction costs.

## **6. PROJECT SCHEDULE**

At the time of the writing of this report, a project schedule has not been developed.

Regarding the construction timeframes needed to complete each alternative, this report cannot speak to construction durations of the proposed improvements. Detailed inspection and analysis as is recommended by this study is needed to identify the specific work activities and durations of the improvements.

## **7. DISCLAIMER**

Kimley-Horn was retained to perform a limited feasibility analysis, and we performed only those tasks specifically stated in our scope of services. The contents of this report are based on visual observations obtained from only the locations observed by the Engineer. There may be variations in materials and environmental conditions from point to point on the structure. It is possible that conditions exist that were not detected by the Engineer's limited visual observations. This report is for the exclusive use of the client. Engineer makes no representations to any other person.

The extent and detail of information is related to the scope of observations and additional information can and should be obtained through more detailed observation or testing. The Owner may consider further observations or testing after receiving this report. If the client obtains additional information subsequent to this report, the Engineer's opinion may no longer be valid without further review of the additional information.

The engineer has no control over the cost of labor, materials, equipment, or over a contractor's methods of determining prices or over competitive bidding or market conditions. Opinions of probable costs provided herein are based on the information known to engineer at this time and represent only the engineer's judgment as a design professional familiar with the construction industry. The engineer cannot and does not guarantee that proposals, bids, or actual construction costs will not vary from its opinions of probable costs.

Engineer's reports are based on the information gathered and constitute an opinion based on professional judgment. No warranty is made, expressed or implied, that deficiencies that may affect life or safety may not exist.

APPENDIX A  
LOCATION MAP



Figure A1: Location Map

**APPENDIX B  
SITE PHOTOS**



*Exhibit B1: South Elevation of Truss Spans*



*Exhibit B2: Span 1 over West River Parkway looking South*



*Exhibit B3: Span 5 over East River Parkway looking North*



*Exhibit B4: Bridge deck looking west*



*Exhibit B5: West Abutment and underside of Span 1 looking west*



*Exhibit B6: West river pier and underside of Span 2 looking east*



*Exhibit B7: East Abutment looking southeast*



*Exhibit B8: Typical lower chord pin and eyebar, south face looking east*



*Exhibit B9: Typical pin and eyebolt connection, north face looking south east*



*Exhibit B10: Truss bearing at West river pier, looking east:*

APPENDIX C  
BRIDGE GEOMETRY

G:\Marketing\Structures Miscellaneous\Short Line Bridge\Short Line Bridge(L5733).dwg February 20, 2019 - 4:38pm

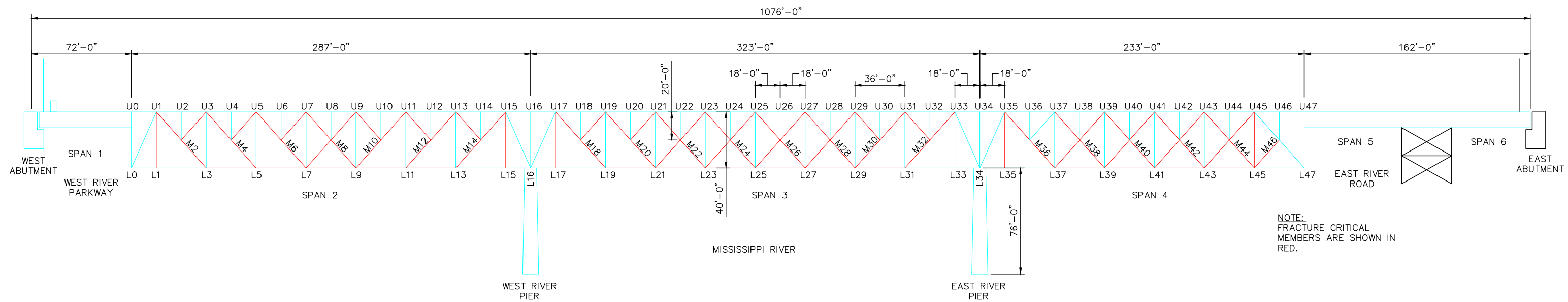

APPENDIX D  
COST & SUMMARY EXHIBITS

**Exhibit D1: Pre-design Opinion of Probable Cost**  
**Alternative 1: Cease Freight Rail Operation, Convert to Shared Use Trail**

Short Line Bridge - Bridge L5733  
 Midtown Greenway Extension across the Mississippi River

Date: 04/12/2019  
 Minneapolis, Minnesota

*Estimate of Construction Costs*

	Description	Unit	Quantity	Unit Price	Extension	Comments
1	Mobilization	Lump Sum	1	\$250,000	\$250,000	Mobilize equipment to site, assume 5% of total construction cost.
2	12-ft wide aluminum decking	Sq. Feet	13,000	\$150	\$1,950,000	Trail decking and support structure to existing truss.
3	Edge Protection Railing	Lin. Feet	2,200	\$175	\$385,000	Galvanized steel 4.5-ft tall fence and anchorages both sides of trail.
4	Bridge Trail Lighting	Lump Sum	1	\$100,000	\$100,000	Light poles, conduit, conductors, service panels.
5	Structural Repairs to Existing Truss	Lump Sum	1	\$485,000	\$485,000	Repairs to existing truss, assumed \$15 per sq. foot of bridge.
6	Provide Structural Redundancy for Truss	Lump Sum	1	\$1,750,000	\$1,750,000	Improvements to provide redundancy, assumed \$50 per sq. foot of bridge.
<b>Construction Cost Subtotal</b>					<b>\$5,000,000</b>	

*Estimate of Indirect Costs*

	Description	Lump Sum	% of Construction Cost	Extension	Comments
1	Inspection and Load Rating for Pedestrian Load	Lump Sum		\$150,000	Hands on Bridge Inspection and Structural Analysis.
2	Design and Plan Preparation		8%	\$400,000	Preparation of Improvement Plans for Bidding.
3	Permitting and Agency Coordination	Lump Sum		\$100,000	Review Process (Corp of Engineers, USFWS, MnDNR, etc.).
4	Construction Phase Services		8%	\$400,000	Management and Oversight during construction.
<b>Indirect Cost Subtotal</b>				<b>\$1,100,000</b>	

**Contingency**

20%

**\$1,300,000**

Unforeseen conditions (% of total construction and indirect costs).

**Overall Cost**

**\$7,400,000**

**Assumptions:**

Railroad property access or acquisition costs are not included.  
 Off bridge trail costs are not included.  
 Bridge painting is not included.

**Exhibit D2: Pre-design Opinion of Probable Cost**

**Alternative 2: Rehabilitate Bridge to provide Freight Rail and Shared Use Trail**

Short Line Bridge - Bridge L5733

Midtown Greenway Extension across the Mississippi River

Date: 04/12/2019

Minneapolis, Minnesota

*Estimate of Construction Costs*

	Description	Unit	Quantity	Unit Price	Extension	Comments
1	Mobilization	Lump Sum	1	\$350,000	\$350,000	Mobilize equipment to site, assume 5% of total construction cost.
2	12-ft wide aluminum decking	Sq. Feet	13,000	\$150	\$1,950,000	Trail decking and support structure to existing truss.
3	Railroad Separation Railing	Lin. Feet	1,100	\$250	\$275,000	Galvanized steel 10-ft tall fence and anchorages.
4	Edge Protection Railing	Lin. Feet	1,100	\$175	\$192,500	Galvanized steel 4.5-ft tall fence and anchorages.
5	Bridge Trail Lighting	Lump Sum	1	\$100,000	\$100,000	Light poles, conduit, conductors, service panels.
6	Structural Repairs to Existing Truss	Lump Sum	1	\$650,000	\$650,000	Repairs to existing truss, assumed \$20 per sq. foot of bridge.
7	Provide Structural Redundancy for Truss	Lump Sum	1	\$3,250,000	\$3,250,000	Improvements to provide redundancy, assumed \$100 per sq. foot of bridge.
<b>Construction Cost Subtotal</b>					<b>\$6,800,000</b>	

*Estimate of Indirect Costs*

	Description	Lump Sum	% of Construction Cost	Extension	Comments	
1	Inspection and Load Rating for Pedestrian Load	Lump Sum		\$150,000	Hands on Bridge Inspection and Structural Analysis.	
2	Design and Plan Preparation		8%	\$544,000	Preparation of Improvement Plans for Bidding.	
3	Permitting and Agency Coordination	Lump Sum		\$100,000	Review Process (Corp of Engineers, USFWS, MnDNR, etc.).	
4	Construction Phase Services		8%	\$544,000	Management and Oversight during construction.	
<b>Indirect Cost Subtotal</b>				<b>\$1,400,000</b>		
<b>Contingency</b>				20%	<b>\$1,700,000</b>	Unforeseen conditions (% of total construction and indirect costs).
<b>Overall Cost</b>					<b>\$9,900,000</b>	<b>Assumptions:</b> Railroad property access or acquisition costs are not included. Off bridge trail costs are not included. Bridge painting is not included.

**Exhibit D3: Pre-design Opinion of Probable Cost**

**Alternative 3: Partially Reconstruct Bridge to provide Freight Rail and Shared Use Trail**

Short Line Bridge - Bridge L5733

Midtown Greenway Extension across the Mississippi River

Date: 04/12/2019

Minneapolis, Minnesota

*Estimate of Construction Costs*

	Description	Unit	Quantity	Unit Price	Extension	Comments
1	Mobilization	Lump Sum	1	\$900,000	\$900,000	Mobilize equipment to site, assume 5% of total construction cost.
2	New Bridge Superstructure	Lump Sum	1	\$16,000,000	\$16,000,000	New redundant truss superstructure, assume \$500 per sq. foot of bridge.
3	12-ft wide aluminum decking	Sq. Feet	13,000	\$150	\$1,950,000	Trail decking.
4	Railroad Separation Railing	Lin. Feet	1,100	\$250	\$275,000	Galvanized steel 10-ft tall fence and anchorages.
5	Edge Protection Railing	Lin. Feet	1,100	\$175	\$192,500	Galvanized steel 4.5-ft tall fence and anchorages.
6	Bridge Trail Lighting	Lump Sum	1	\$100,000	\$100,000	Light poles, conduit, conductors, service panels.
<b>Construction Cost Subtotal</b>					<b>\$19,500,000</b>	

*Estimate of Indirect Costs*

	Description	Lump Sum	% of Construction Cost	Extension	Comments
1	Inspection and Load Rating for Pedestrian Load	Lump Sum		\$150,000	Hands on Bridge Inspection and Structural Analysis.
2	Design and Plan Preparation		8%	\$1,560,000	Preparation of Improvement Plans for Bidding.
3	Permitting and Agency Coordination	Lump Sum		\$100,000	Review Process (Corp of Engineers, USFWS, MnDNR, etc.).
4	Construction Phase Services		8%	\$1,560,000	Management and Oversight during construction.
<b>Indirect Cost Subtotal</b>				<b>\$3,400,000</b>	
<b>Contingency</b>			20%	<b>\$4,600,000</b>	Unforeseen conditions (% of total construction and indirect costs).
<b>Overall Cost</b>				<b>\$27,500,000</b>	<b>Assumptions:</b> Railroad property access or acquisition costs are not included. New railroad track is not included. Bridge substructures can sustain new superstructure. Off bridge trail costs are not included. Bridge painting is not included.

**Exhibit D4: Pre-design Opinion of Probable Cost**

**Alternative 4: Provide supplemental structure above the existing bridge to provide Freight Rail and Shared Use Trail**

Short Line Bridge - Bridge L5733

Date: 04/12/2019

Midtown Greenway Extension across the Mississippi River

Minneapolis, Minnesota

*Estimate of Construction Costs*

	Description	Unit	Quantity	Unit Price	Extension	Comments
1	Mobilization	Lump Sum	1	\$800,000	\$800,000	Mobilize equipment to site, assume 5% of total construction cost.
2	Supplemental Support for Trail above Railroad	Lump Sum	1	\$4,850,000	\$4,850,000	New deck level for trail, assumed \$150 per sq. foot of bridge.
3	12-ft wide aluminum decking	Sq. Feet	13,000	\$150	\$1,950,000	Trail decking and support structure to supplemental support.
4	Edge Protection Railing	Lin. Feet	2,200	\$175	\$385,000	Galvanized steel 4.5-ft tall fence and anchorages, both sides of trail.
5	Bridge Trail Lighting	Lump Sum	1	\$100,000	\$100,000	Light poles, conduit, conductors, service panels.
6	Approach Ramp Structure	Lump Sum	1	\$3,750,000	\$3,750,000	Assumes 540-ft-long access ramp, 5% max. grade, adjacent to railroad.
7	Structural Repairs to Existing Truss	Lump Sum	1	\$650,000	\$650,000	Repairs to existing truss, assumed \$20 per sq. foot of bridge.
8	Provide Structural Redundancy for Truss	Lump Sum	1	\$3,250,000	\$3,250,000	Improvements to provide redundancy, assumed \$100 per sq. foot of bridge.
<b>Construction Cost Subtotal</b>					<b>\$15,800,000</b>	

*Estimate of Indirect Costs*

	Description	Lump Sum	% of Construction Cost	Extension	Comments
1	Inspection and Load Rating for Pedestrian Load	Lump Sum		\$150,000	Hands on Bridge Inspection and Structural Analysis.
2	Design and Plan Preparation		8%	\$1,264,000	Preparation of Improvement Plans for Bidding.
3	Permitting and Agency Coordination	Lump Sum		\$100,000	Review Process (Corp of Engineers, USFWS, MnDNR, etc.).
4	Construction Phase Services		8%	\$1,264,000	Management and Oversight during construction.
<b>Indirect Cost Subtotal</b>				<b>\$2,800,000</b>	

**Contingency**

20%

**\$3,800,000**

Unforeseen conditions (% of total construction and indirect costs).

**Overall Cost**

**\$22,400,000**

**Assumptions:**

Railroad property access or acquisition costs are not included.  
Off bridge trail costs are not included, except the access ramp structure.  
Bridge painting is not included.

**Exhibit D5: Pre-design Opinion of Probable Cost Summary**

Short Line Bridge - Bridge L5733

Midtown Greenway Extension across the Mississippi River

Date: 04/12/2019

Minneapolis, Minnesota

	<i>Construction Cost Subtotal</i>	<i>Indirect Cost Subtotal</i>	<i>Contingency</i>	<b><i>Overall Cost</i></b>
Alternative 1: Cease Freight Rail Operation, Convert to Shared Use Trail	\$5,000,000	\$1,100,000	\$1,300,000	<b>\$7,400,000</b>
Alternative 2: Rehabilitate Bridge to provide Freight Rail and Shared Use Trail	\$6,800,000	\$1,400,000	\$1,700,000	<b>\$9,900,000</b>
Alternative 3: Partially Reconstruct Bridge to provide Freight Rail and Shared Use Trail	\$19,500,000	\$3,400,000	\$4,600,000	<b>\$27,500,000</b>
Alternative 4: Provide supplemental structure above the existing bridge to provide Freight Rail and Shared Use Trail	\$15,800,000	\$2,800,000	\$3,800,000	<b>\$22,400,000</b>

**Exhibit D6: Alternative Consideration Summary**

Short Line Bridge - Bridge L5733  
 Midtown Greenway Extension across the Mississippi River

Date: 04/12/2019  
 Minneapolis, Minnesota

	<i>Trail Layout</i>	<i>Safety</i>	<i>Trail Connectivity</i>	<i>Railroad Agreements</i>	<i>Redundancy</i>	<i>Aesthetic Impacts</i>	<i>Historical Impacts</i>	<i>Viewshed Impacts</i>
Alternative 1: Cease Freight Rail Operation, Convert to Shared Use Trail	Trail centered on existing bridge	4.5-ft railings each side of trail	Direct connection to existing Greenway & railroad grade	Need to acquire railroad right-of-way or use agreement	Bridge redundancy improvements provided	None	None	None
Alternative 2: Rehabilitate Bridge to provide Freight Rail and Shared Use Trail	Trail adjacent existing freight railroad on existing bridge	10-ft fence on north side of trail, 4.5-ft fence on south side	Direct connection to existing Greenway & railroad grade	Need to acquire railroad right-of-way or use agreement	Bridge redundancy improvements provided	Railroad separation fence will impact aesthetics	None	Railroad separation fence will impact north viewshed
Alternative 3: Partially Reconstruct Bridge to provide Freight Rail and Shared Use Trail	Trail adjacent existing freight railroad on new bridge superstructure	10-ft fence on north side of trail, 4.5-ft fence on south side	Direct connection to existing Greenway & railroad grade	Need to acquire railroad right-of-way or use agreement	Bridge redundancy improvements provided	Railroad separation fence will impact aesthetics	None	Railroad separation fence will impact north viewshed
Alternative 4: Provide supplemental structure above the existing bridge to provide Freight Rail and Shared Use Trail	Trail above existing freight railroad on supplemental bridge superstructure	4.5-ft railings each side of trail	Significant ramps (~540-ft long) required at each end of the bridge	Need to acquire railroad right-of-way or use agreement	Bridge redundancy improvements provided	Potential impacts depending on supplemental structure type	Potential impacts depending on supplemental structure type	None