



Marine Safety Center Technical Note

Date: September 7, 2001
SSIC: 16717/46 CFR 69/P002131
MTN: 01-99 CH-3

Subj: CHANGE 3 (CH-3) TO MTN 01-99, TONNAGE TECHNICAL POLICY

1. Purpose: This Marine Safety Center Technical Note (MTN) 01-99 amends the Tonnage Technical Policy to provide for ignoring from convention measurement uncovered cargo deck spaces on offshore supply vessels under novel vessel provisions, and to incorporate a correction to a figure that applies to simplified measurement of trimarans.
2. Applicability: Tonnage measurement in accordance with the interpretations of this MTN is required for vessels for which the application of a law of the United States to the vessel depends on the vessel's tonnage. Refer to Navigation and Vessel Inspection Circular (NVIC) 11-93 for information regarding applicability of tonnage measurement systems to U.S. flag vessels.
3. Action: The Tonnage Technical Policy, as amended by Change 3, is attached as Enclosure (1). Enclosure (2) provides a summary of specific changes implemented by Change 3. Authorized measurement organizations are requested to apply the technical interpretations in Enclosure (1) immediately. Any deviation from this policy requires written approval from the Marine Safety Center (MSC).

A handwritten signature in black ink, appearing to read "A. L. PEEK".

A. L. PEEK

Encl: (1) Tonnage Technical Policy
(2) Changes in MTN 01-99 CH-3

(Page intentionally left blank)

U.S. COAST GUARD

MARINE SAFETY CENTER



TONNAGE TECHNICAL POLICY

This document provides technical policy for use in interpreting the provisions of Title 46, Code of Federal Regulations, Part 69. This document is based on a reprint of 46 CFR 69 Subparts B and E in standard text with interpretive material in italicized format. Figures from the regulation have been inserted in the appropriate location within the document, with references to the figures deleted. Any request for a deviation from this policy shall be submitted in writing to the U.S. Coast Guard Marine Safety Center.

(Page intentionally left blank)

TABLE OF CONTENTS

TABLE OF CONTENTS	i
SUBPART B - CONVENTION MEASUREMENT SYSTEM	1
69.51 PURPOSE	1
69.53 DEFINITIONS	1
69.55 APPLICATION FOR MEASUREMENT	7
69.57 GROSS TONNAGE	7
69.59 ENCLOSED SPACES	7
69.61 EXCLUDED SPACES	9
(a) GENERAL	9
(b) SPACE OPPOSITE END OPENING	9
(c) COVERED SPACE OPEN ON SIDES	10
(d) COVERED SPACE IN WAY OF SIDE OPENINGS	11
(e) SPACE BELOW UNCOVERED OPENING	12
(f) RECESSES	12
(f) SPACE OPEN TO THE SEA	12
(g) ADDITIONAL RESTRICTIONS ON EXCLUDED SPACES	13
69.62 CARGO SPACES	13
(a) SPACES INCLUDED IN V_c	13
(b) SPACES NOT INCLUDED IN V_c	14
69.63 NET TONNAGE	15
69.65 CALCULATION OF VOLUMES	15
(a) NAVAL ARCHITECTURAL PRACTICES	15
(b) HULL VOLUME	15
(c) DECK STRUCTURE VOLUME	16
(d) TERMINATION OF MEASUREMENTS	19
(e) MEASURING CARGO SPACES	19
(f) PRECISION OF MEASUREMENTS	19
(g) CALCULATION WORKSHEET	19
(h) SPACES IGNORED FROM MEASUREMENT	19
69.67 MARKING OF CARGO SPACES	20
69.69 ISSUANCE OF AN INTERNATIONAL TONNAGE CERTIFICATE (1969)	20
69.71 CHANGE OF NET TONNAGE	20
(a) NET TONNAGE INCREASES	20
(b) VESSEL WITH DIFFERENT LOAD LINES ASSIGNED	20
(c) NET TONNAGE DECREASES	20
69.73 VARIANCE FROM THE PRESCRIBED MEASUREMENT METHOD	21
(a) NOVEL VESSEL DETERMINATION	21
(b) SUBMITTAL OF DETERMINATION REQUESTS	21
69.80 OPEN-TOP CONTAINERSHIPS	21
(a) UPPER DECK DETERMINATION	21
(b) ENCLOSED SPACES	21
(c) TREATMENT OF SHELTER ABOVE CONTAINERSTACKS	21
69.81 OFFSHORE SUPPLY VESSELS	21
69.85 REDUCED GROSS TONNAGE	22
(a) VESSELS WITH QUALIFYING SEGREGATED BALLAST TANKS	22
(b) OPEN-TOP CONTAINERSHIPS	22
SUBPART C - STANDARD MEASUREMENT SYSTEM (UNDER DEVELOPMENT)	
SUBPART D - DUAL MEASUREMENT SYSTEM (UNDER DEVELOPMENT)	

TABLE OF CONTENTS (CONT.)

SUBPART E - SIMPLIFIED MEASUREMENT SYSTEM	23
69.201 PURPOSE	23
69.203 DEFINITIONS	23
69.205 APPLICATION FOR MEASUREMENT SERVICES	25
69.207 MEASUREMENTS	25
69.209 CALCULATION OF TONNAGES	26
(a) GROSS TONNAGE	26
(b) NET TONNAGE	27
(c) <i>TONNAGE OF NOVEL CRAFT</i>	28
APPENDIX	
A GRANDFATHERING PROVISIONS	A-1

CONVENTION MEASUREMENT SYSTEM (46 CFR 69 SUBPART B)

69.51 PURPOSE

This subpart prescribes the requirements for measuring a vessel in order to comply with the International Convention on Tonnage Measurement of Ships, 1969 (Convention), and 46 U.S.C. chapter 143.

69.53 DEFINITIONS

As used in this subpart -

AMIDSHIPS means the midpoint of the registered length, as "registered length" is defined in this section, where the forward terminal of that length coincides with the fore side of the stem.

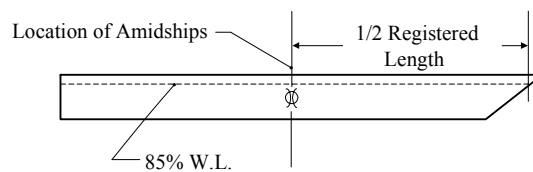

BOUNDARY BULKHEAD means the bulkhead or partition that separates an enclosed interior space from the surrounding weather. In general, the exterior bulkhead of a deck structure is the boundary bulkhead.

BULWARK means that part of a vessel's side above the upper deck that serves to protect the upper deck from exposure to the sea. Structures above the upper deck at the vessel's side that contain enclosed volume are not bulwarks, but rather are considered as superstructure spaces.

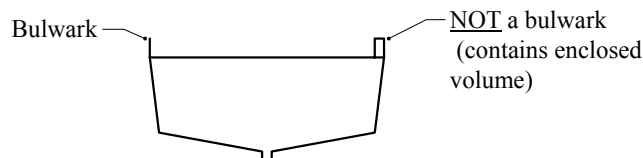

CARGO SPACE means an enclosed space appropriated for the transport of cargo which is to be discharged from the vessel. The term does not include a space which qualifies as an excluded space under § 69.61.

CEILING is defined in § 69.103.

CLEAN BALLAST TANK (CBT) means a dual use tank that can contain either cargo or water ballast and is fitted with an oil/water separation system. A dedicated clean ballast tank is a cargo tank used for water ballast only.

DECK CARGO is freight carried on the weather decks of a vessel for the sole purpose of its transport between two separate and distinct locations and which is off-loaded from the vessel in its original container (if applicable) without undergoing any processing or other use while onboard the vessel. For example, a JP-5 fuel tank being transported to an offshore platform and hoisted on board the platform with its original contents intact is considered deck cargo. If for the same tank, shipboard pumps were used to off-load the JP-5 to the platform, the tank would be considered temporary deck equipment, and not deck cargo. Note that the method of attachment does not determine whether an item is considered

deck cargo. A bona fide shipping container can either be lashed or welded to the deck, provided it meets all the criteria for deck cargo as outlined above.

DECK STRUCTURE is any structure that is on or above the upper deck. Examples of deck structures are superstructures and deckhouses.

ENCLOSED SPACE is defined in § 69.59.

EXCLUDED SPACE is defined in § 69.61.

END OPENING is a covered enclosed space in the fore or aft end of a deck structure, which is bounded by less than two boundary bulkheads of the structure. (See the illustration under "Recess.")

FLAT PLATE KEEL is the horizontal, centerline, bottom shell strake constituting the lower flange of the keel. The "top of the flat plate keel" refers to the top of this plate. In vessels that do not have a flat plate keel, the equivalent to the "top of the flat plate keel" is established as described in the definition for molded depth.

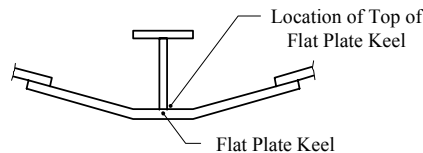

GROSS TONNAGE or GT means the tonnage determined under § 69.57. Gross tonnage is a measure of the overall size of a vessel.

LEAST MOLDED DEPTH (D_{lm}) means the vertical distance between: 1) the top of the flat plate keel (or equivalent) at the lowest point along its length; and 2) the horizontal line that is tangent to the underside of the upper deck at the vessel's side at the lowest point along the upper deck's length. For the purposes of this definition, the vessel is considered to be trimmed on a waterline parallel to the design waterline.

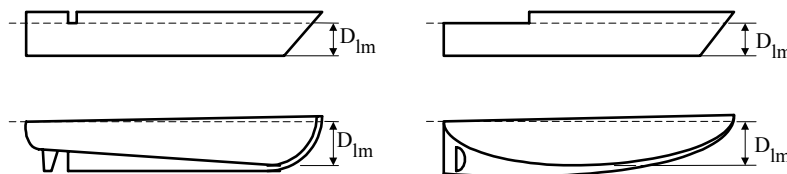

LINE OF THE UPPER DECK means a longitudinal line at the underside of the upper deck or, if that deck is stepped, the longitudinal line of the underside of the lowest portion of that deck parallel with the upper portions of that deck. Discontinuities in the upper deck that do not extend from side to side of the vessel, are one meter or less in length, or are outside the boundaries of "registered length," are ignored when establishing the line of the upper deck.

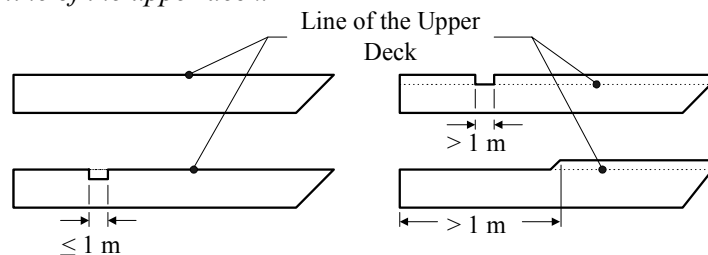

MOLDED DEPTH means the vertical distance amidships between the following points:

- (a) **Upper Terminus** From the line of the upper deck at the vessel's side or, if the vessel has rounded gunwales, from the intersection of the line of the upper deck extended to the molded line of the shell plating as though the gunwales were of angular design.

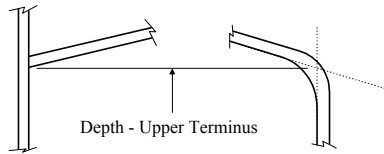

- (b) **Lower Terminus** To the top of the flat plate keel, or equivalent (i.e. to the lower edge of the keel rabbet if the vessel is of wood or composite structure, or to the point where the line of the flat of the bottom extended inward cuts the side of the keel if the vessel's lower part is hollow or has thick garboards).

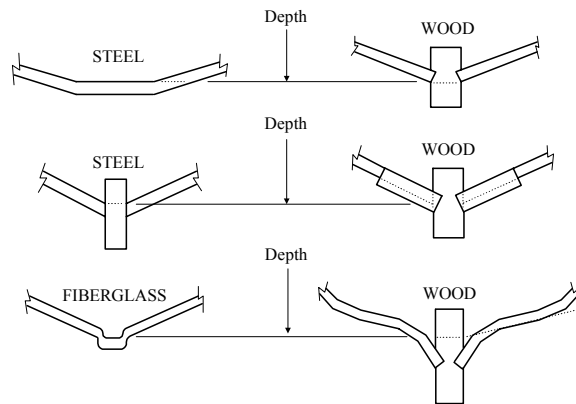

MOLDED DRAFT means -

- (a) **Vessels Assigned Load Line Under Parts 42, 44, 45 or 47** For vessels assigned a load line under parts 42, 44, 45, or 47 of this chapter, the draft corresponding to the Summer Load Line (other than a timber load line), measured from the lower terminus of the molded depth to the upper edge of the horizontal line through the load line (Plimsoll) mark.

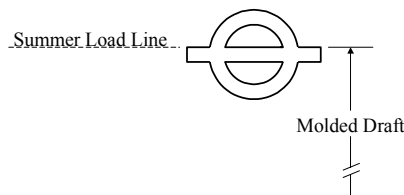

- (b) **Passenger Vessels Assigned Load Line Under Part 46** For passenger vessels assigned a load line under part 46 of this chapter, the draft corresponding to the deepest subdivision load line assigned

- (c) **Other Vessels Assigned Load Line** For vessels to which parts 42, 44, 45, 46, or 47 of this chapter do not apply but which otherwise have been assigned a load line, the draft corresponding to the Summer Load Line so assigned;

- (d) **Vessels Otherwise Restricted in Draft** For vessels to which no load line has been assigned but the draft of which is restricted under any Coast Guard requirement, the maximum draft permitted under the restriction; and
- (e) **All Other Vessels** For other vessels, 75 percent of the molded depth.

NET TONNAGE or NT means tonnage determined under §69.63. *NT is a measure of the useful capacity of a vessel.*

OPEN-TOP CONTAINERSHIP is a vessel designed for the carriage of containers in holds which are not fitted with hatch covers. In section, it is “U” shaped, with a double bottom and high coamings on the upper deck to protect the cargo holds and without a complete deck above the molded draft. A complete deck is one which extends from stem to stern and side to side at all points of its length.

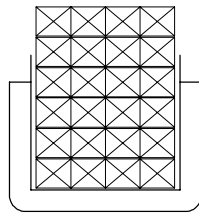

PASSENGER means a person on board a vessel other than -

- (a) The master, a member of the crew, or other person employed or engaged in any capacity in the business of the vessel; and
- (b) A child under one year of age.

RECESS is a covered enclosed space in a deck structure, which is bounded on at least two sides by the boundary bulkhead of the structure.

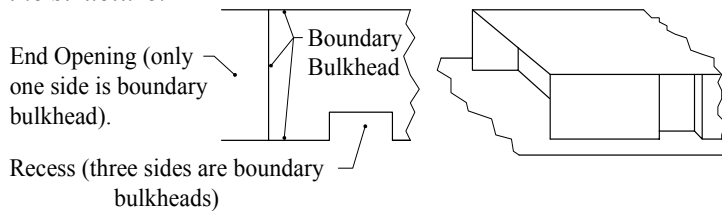

REGISTERED BREADTH means the maximum breadth of a vessel’s hull measured amidships to the molded line of the frame in a vessel with a metal shell and to the outer surface of the hull in all other vessels.

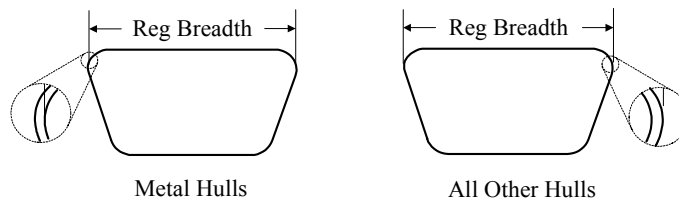

REGISTERED DEPTH means the molded depth as defined in this section. For vessels that are not monohulls (e.g. catamarans, trimarans, SWATH's), the registered depth shall be the molded depth of the deepest hull(s).

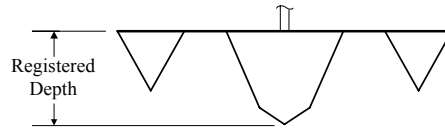

REGISTERED LENGTH means

- (a) **Monohull Vessels:** - For monohull vessels, either 1) 96 percent of the length from the fore side of the stem to the aftermost side of the stern on a waterline at 85 percent of the least molded depth measured from the top of the flat plate keel; or 2) the length from the fore side of the stem to the axis of the rudder stock on that waterline, whichever is greater.

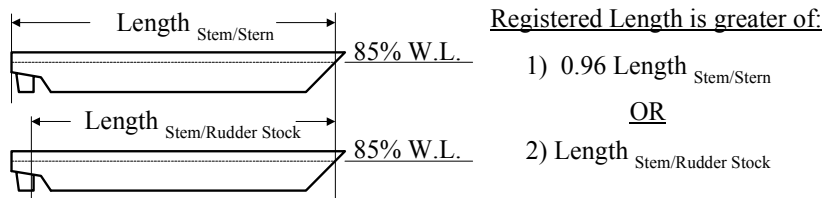

- (i) In vessels designed with a rake of keel, this length is measured on a waterline parallel to the design waterline. For such cases, the reference point used to establish the 85% waterline is taken at the point where the top of the flat plate keel, or equivalent, is lowest along the length of the vessel.

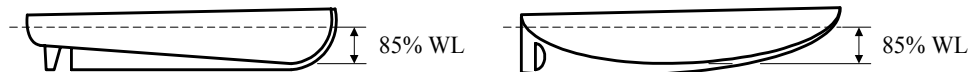

- (ii) In vessels fitted with an alternate steering device installed in place of the rudder (e.g. trainable propulsion unit, cycloidal propeller, etc.), the centerline of the axis of rotation of the device is considered equivalent to the axis of the rudder stock for purposes of establishing the length measurement. If more than one such device is installed, the axis of rotation of the aftermost device is considered equivalent to the axis of the rudder stock.

- (iii) In all vessels, the stem and stern define the foremost and aftermost boundaries, respectively, of the buoyant hull envelope. Any attachment to the hull, such as a swim platform that is not part of the hull and does not contain buoyant volume, is ignored from measurements taken to the stem/stern.

(b) **Multihull Vessels** - For multihull vessels (such as SWATH's, catamarans, trimarans, semi-sub MODU's, etc.), the registered length as defined under the simplified measurement system (§ 69.203).

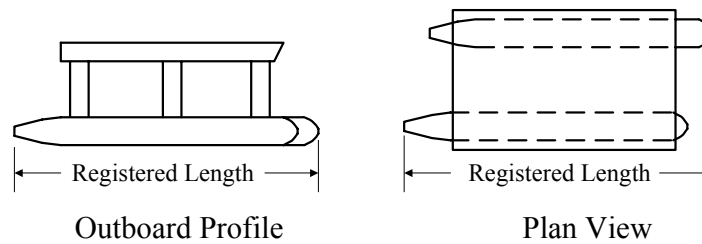

SEGREGATED BALLAST TANK (SBT) means a tank exclusively used for the carriage of segregated water ballast, and which is completely separated from the cargo oil and fuel oil systems.

SPARRING is wooden protection of vertical surfaces in way of frames in cargo holds, also called cargo battens. Sparring is also used in spaces designed for bulk stowage and refrigerated stores in order to allow for ventilation.

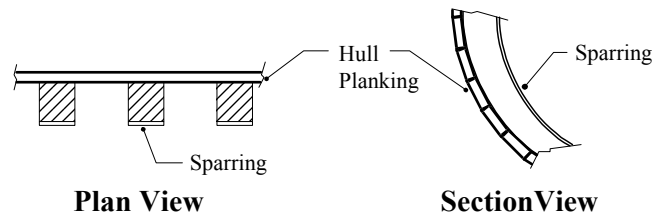

TEMPORARY DECK EQUIPMENT means any item of a semi-permanent nature which is located on the weather deck of a vessel and which cannot be considered as deck cargo. Examples of temporary deck equipment include processing tanks, seismic trailers, and portable machinery that is operated on the ship.

UPPER DECK means the uppermost complete deck exposed to weather and sea, which has permanent means of weathertight closing of all openings in the weather part of the deck, and below which all openings in the sides of the vessel are fitted with permanent means of watertight closing.

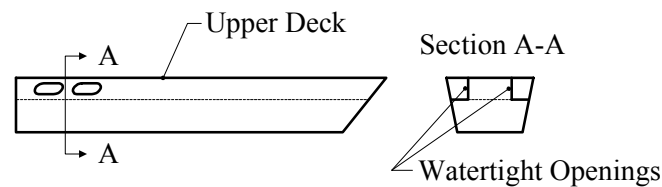

For a vessel having openings in the side of the vessel below the uppermost continuous (or "complete") deck, which are not closed but limited inboard by weathertight versus watertight bulkheads and decks, the deck below such openings should be considered the upper deck.

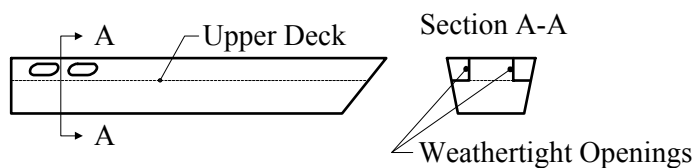

WEATHERTIGHT means secure against penetration of water into the vessel in any sea condition, including intermittent immersion such as wave action and spray.

WATERTIGHT means capable of preventing the passage of water through the structure or closure in any direction under a head of water for which the surrounding structure is designed.

69.55 APPLICATION FOR MEASUREMENT

Applications for measurement under this subpart must include the following information and plans:

- (a) Type of vessel
- (b) Vessel's name and official number (if assigned).
- (c) Builder's name and the vessel hull number assigned by *the* builder.
- (d) Place and year built.
- (e) Date keel was laid.
- (f) Overall length, breadth, and depth of vessel.
- (g) Lines plan.
- (h) Booklet of offsets at stations.
- (i) Capacity plans for tanks and cargo compartments.
- (j) Hydrostatic curves.
- (k) Construction plans showing measurements and scantlings of deck structures, hatches, appendages, recesses, and other enclosed spaces.
- (l) Arrangement plans.

69.57 GROSS TONNAGE

Gross Tonnage (GT) is determined by the following formula:

$$GT = K_1 V$$

in which:

V = total volume of all enclosed spaces in cubic meters; and

K₁ = **0.2 + 0.02 log₁₀ V.**

The final figures determined by the above formula and stated on the appropriate tonnage certificate(s) should be given in rounded down figures without decimals.

69.59 ENCLOSED SPACES

Enclosed space means a space which is bounded by the vessel's hull, by fixed or portable partitions or bulkheads, or by decks or coverings other than permanent or movable awnings. *In general, a space is considered an enclosed space if it is:*

- (a) covered from above (excepting awnings) and below; **or**

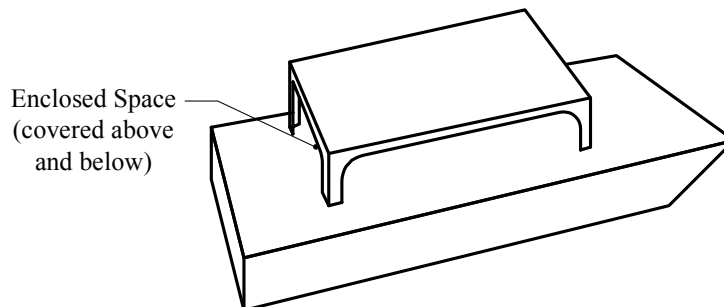

- (b) covered from above or below and enclosed on three or more sides by partitions or bulkheads that exceed 5 feet (1.5 meters) in height as measured from the lowest point of the enclosed space (refer to § 69.81 for exception for offshore supply vessels (OSV's)).

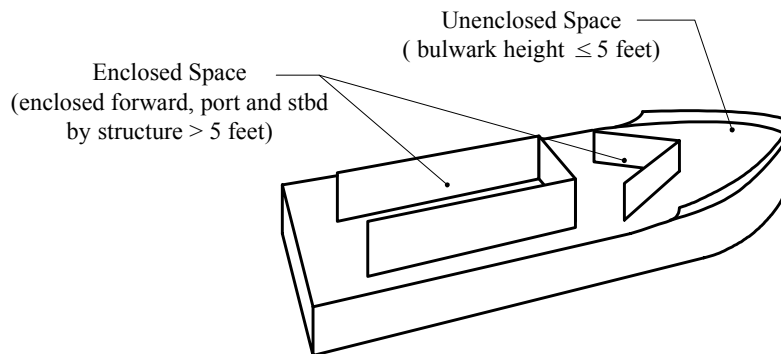

In the situation where only a portion of a bulkhead or partition exceeds 5 feet (1.5 meters) in height, the entire inboard space in way of that portion of the structure from the deck to the top of the structure must be included in the total volume of all enclosed spaces (V).

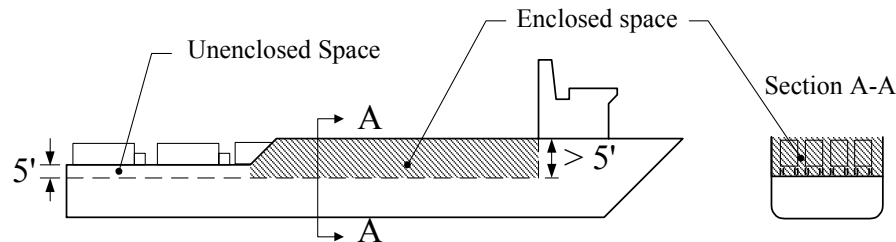

No break (e.g. step) in a deck, nor any opening in the vessel's hull, in a deck or in a covering of a space, or in the partitions or bulkheads of a space, nor the absence of a partition or bulkhead precludes the space from being included in the *total volume of all enclosed spaces (V)*. The following miscellaneous spaces are considered enclosed spaces:

- (a) Temporary deck equipment which has enclosed volume (e.g., processing tanks, seismic trailers, housed portable machinery, etc.).
- (b) Spaces below cargo hatches of multipurpose vessels which have the facility to trade with cargo hatches open or closed, regardless of the hatch position when the vessel is measured.
- (c) Appendages which have enclosed volume (except for movable items such as rudders which can be considered as unenclosed machinery and thereby ignored from measurement).
- (d) Uncovered spaces bounded on three sides by bulwarks - or portions of bulwarks - that exceed 5 feet (1.5 meters) in height.

69.61 EXCLUDED SPACES

(a) GENERAL

Excluded space means an enclosed space which is excluded from *the total volume of all enclosed spaces* (V) in calculating gross tonnage. Except as under paragraph (g) of this section, this section lists the excluded spaces.

(b) SPACE OPPOSITE END OPENINGS

A space that is within a *deck* structure and that is opposite an end opening extending from deck to deck (except for a curtain plate of a height not exceeding by more than one inch the depth of the adjoining deck beams) and having a breadth equal to or greater than 90 percent of the breadth of the *deck structure at deck level* at the line of the opening is an excluded space, subject to the following:

- (1) **Unrestricted End Opening** Only the space between the actual end opening and a line drawn parallel to the line or *the face* of the opening at a distance from the opening equal to one-half of the breadth of the *deck structure at deck level* at the line of the opening is excluded.

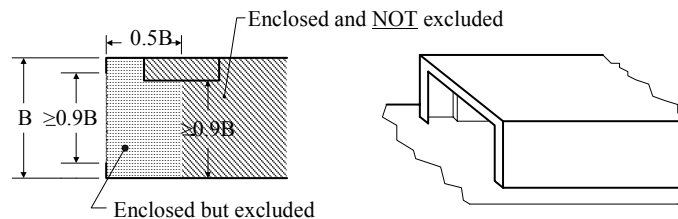

- (2) **Restricted End Opening** If, because of any arrangement (except convergence of the outside plating as shown *below*), the breadth of the space is less than 90 percent of the breadth of the *deck structure at deck level*, only the space between the line of the opening and a parallel line drawn through the point where the athwartship breadth of the space is equal to 90 percent or less of the breadth of the *deck structure at deck level* is excluded.

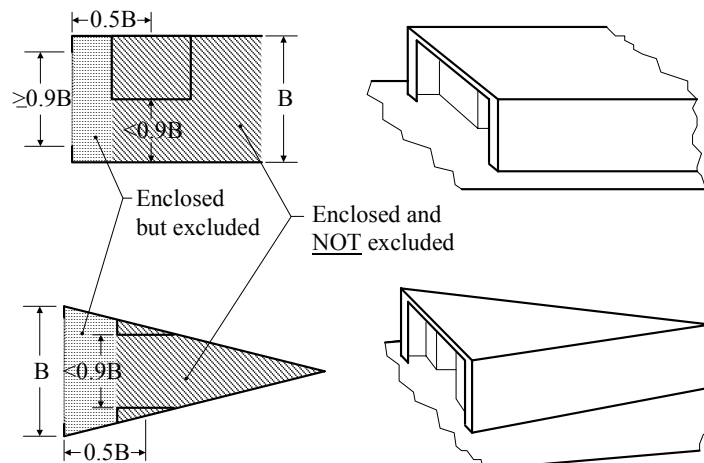

For the situation where the breadth of the space decreases solely due to the convergence of the outside plating, the 90% restriction does not apply.

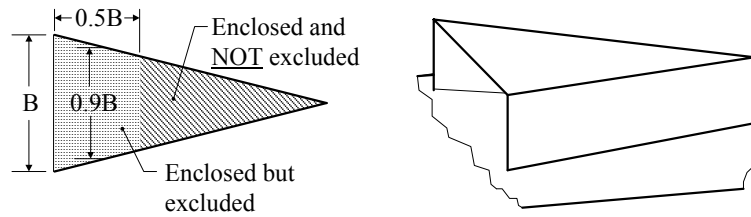

(3) **Excluded Spaces Separated by Open Space** When any two spaces, either of which is excluded under paragraphs (b)(1) or (b)(2) of this section, are separated by an area that is completely open except for bulwarks or open rails, these two spaces must not be excluded if the separation between the two spaces is less than the least half breadth of the deck in way of the separation.

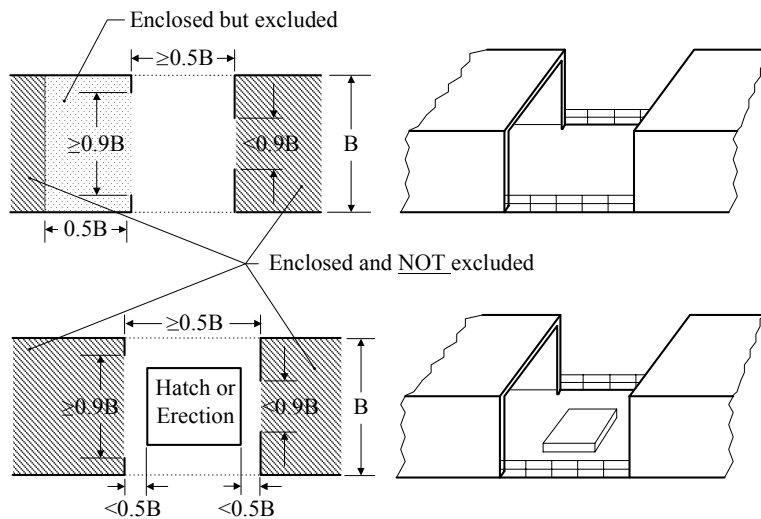

(4) **Determining Breadth of Deck (B)** When the deck at the line of an opening has rounded gunwales, the breadth of the deck is the distance between the tangent points indicated below.

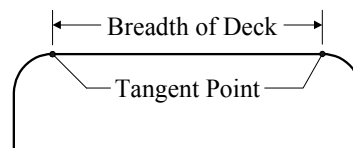

(c) **COVERED SPACE OPEN ON SIDES**

A space that is open to the weather and that is under an overhead deck covering with no connection on the space's exposed sides between the covering and the deck other than the stanchions necessary for the covering's support is an excluded space. An open rail or bulwark fitted at the vessel's side does not disqualify the space from being an excluded space if the height

between the top rail or bulwark and the overhead structure or curtain plate (if fitted) is not less than 2.5 feet or one-third of the height of the space, whichever is greater.

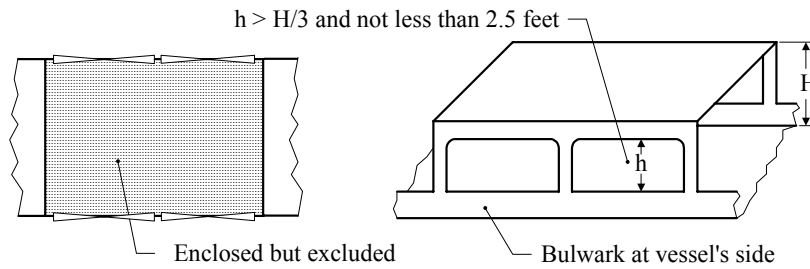

These same requirements apply to the situation where an interior structure partially supports the overhead deck covering.

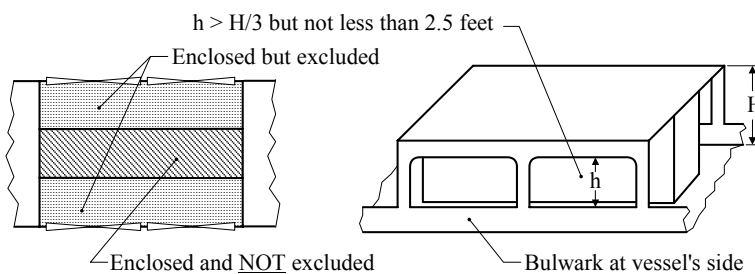

(d) COVERED SPACE IN WAY OF SIDE OPENINGS

A space in a side-to-side *deck* structure directly in way of opposite side openings not less than 2.5 feet in height or one-third of the height of the structure, whichever is greater, is an excluded space.

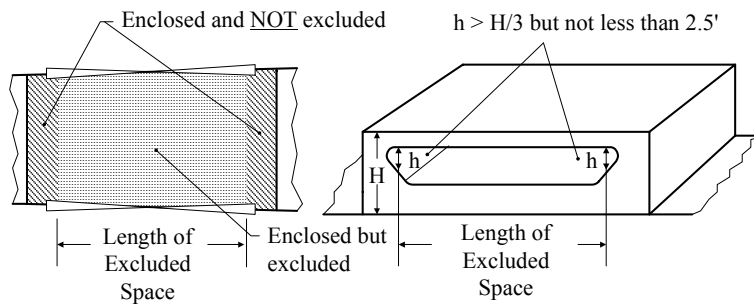

If the opening is only on one side of the *deck* structure, the space to be excluded is limited inboard from the opening to a maximum of one-half the breadth of the deck in way of the opening

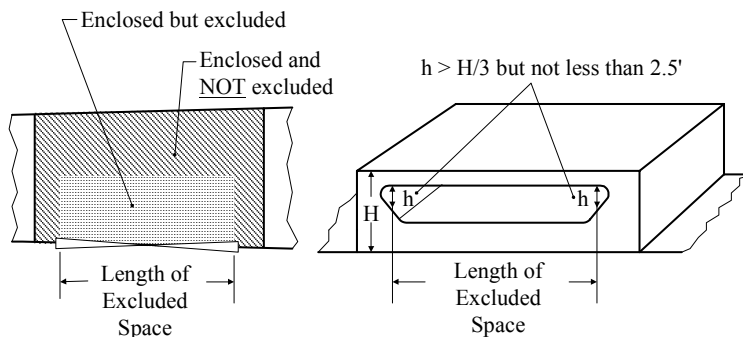

(e) **SPACE BELOW UNCOVERED OPENING**

A space in a *deck* structure immediately below an uncovered opening in the deck overhead or that is otherwise open from above is an excluded space, if the opening is exposed to the weather and the space to be excluded is limited to the area of the opening.

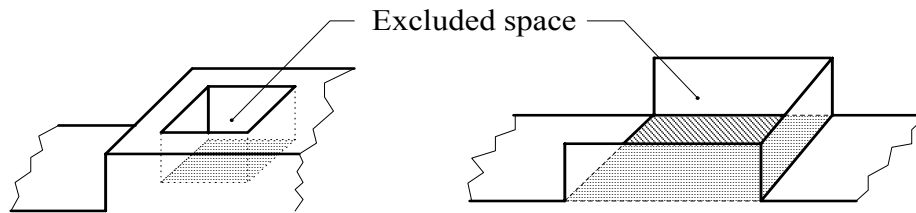

(f) **RECESSES**

A recess in a *deck* structure which is exposed to the weather and which has an opening that extends from deck to deck without a means of closing is an excluded space, if the interior width of the space is not greater than the width of the opening and extension of the space into the structure is not greater than twice the width of the opening. *In order to be considered to extend from deck to deck, the depth of any curtain plate at the entrance of the recess cannot exceed by more than one inch the depth of the adjoining deck beams.*

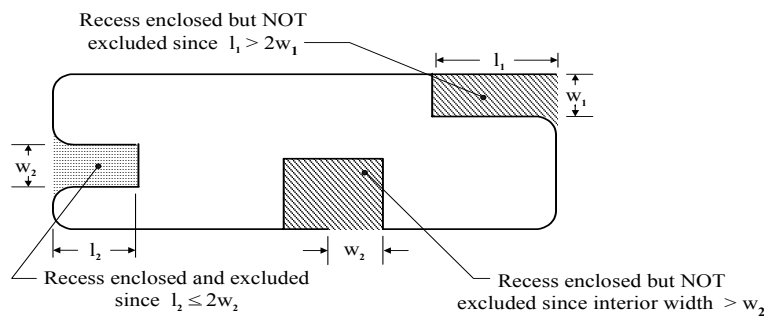

(f') **SPACE OPEN TO THE SEA**

An enclosed space that is open to the sea is an excluded space. For a space to be considered open to the sea, the space must be located below the upper deck and, when the vessel is hypothetically immersed to the upper deck, the space must fill with water. In addition, a space can be considered open to the sea only if the space can fill with water without any detrimental effect on the operation of the vessel.

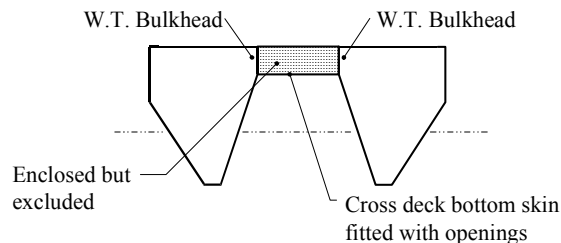

Hawse pipes, sea valve recesses, thruster tunnels, stern chutes in fishing vessels, and dredging wells in dredgers are generally treated as spaces open to the sea. Accordingly, they may be eligible for treatment as excluded spaces.

(g) **ADDITIONAL RESTRICTIONS ON EXCLUDED SPACES**

Any space described in paragraphs (b) through (f') of this section which fulfills at least one of the following conditions is **not** an excluded space (*i.e. cannot be excluded from the total volume of all enclosed spaces (V)*):

- (1) **Space Fitted With Means of Securing Cargo or Stores** The space is fitted with shelves or other means designed for securing cargo or stores. *This includes stanchions, fences and railings for restraining livestock. This does not include passenger benches/seats and shelves/racks for safety equipment, such as fire extinguishers, life jackets, and life rafts.*
- (2) **Opening Fitted With Closure Means** The opening that would otherwise permit the space to be excluded space is fitted with a means of closure.
- (3) **Opening Can Otherwise be Closed** Other features of the space make it possible for the space to be closed.

69.62 CARGO SPACES

The total volume of all cargo spaces (V_c) is used to calculate net tonnage. Information on specific cargo related spaces and how they are treated is provided below:

(a) **SPACES INCLUDED IN V_c**

Cargo related spaces that are included in the total volume of cargo spaces (V_c):

- (1) **Clean Ballast Tanks** *Clean ballast tanks in oil tankers when the vessel is fitted with a crude oil washing system which would permit dual purpose cargo/clean ballast tank use of the tanks.*
- (2) **Slop Tanks** *Slop tanks for cargo residue.*
- (3) **Fish Processing Spaces** *In fishing vessels, fish processing spaces for fishmeal, liver oil and canning, tanks for re-cooling fish, wet fish bunkers, and stores for salt, spices, oil and tare.*
- (4) **Refrigeration Machinery Spaces** *Refrigerating machinery spaces associated with refrigerating cargoes, situated within the boundaries of the cargo spaces.*
- (5) **Dual Purpose Spaces** *Dual purpose spaces which carry cargo at any time, such as tanks used for both ballast and cargo.*
- (6) **Automobile Spaces** *Spaces allocated to passenger automobiles.*
- (7) **Passenger Service Spaces** *Mail rooms, baggage compartments separate from passenger accommodations, and bonded stores for passengers.*
- (8) **Space in Pontoon Hatch Covers** *Weathertight steel pontoon hatch covers on hatchway coamings, if such covers are open on the underside.*

(9) **Dock Deck Areas** *The space within the dock of a dockship.*

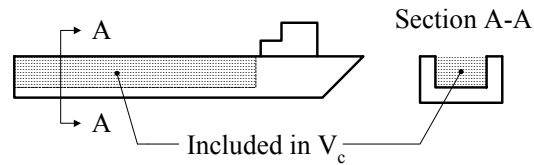

(10) **Cargo Spaces Temporarily Open to the Sea** *Cargo spaces within the hulls of vessels such as split-hull barges and dredgers that are open to sea when cargo is discharged.*

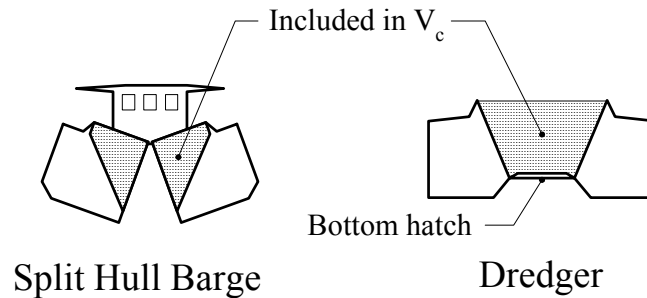

(11) **Hoppers on Deck Barges** *Cargo spaces within a hopper or similar structure on deck barges. Note that under the provisions of Section 69.59, these spaces should be ignored from volume calculations if the height of the hopper above the deck does not exceed 5 feet (1.5 meters).*

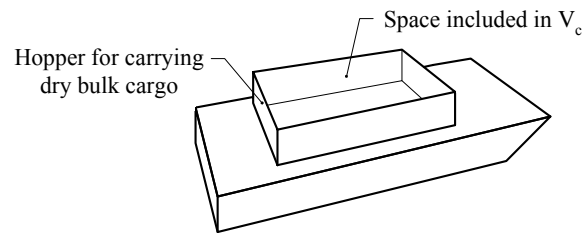

(b) **SPACES NOT INCLUDED IN V_c**

Cargo related spaces that are not included in the total volume of cargo spaces V_c :

(1) **Segregated Ballast Tanks**

(2) **Dedicated Clean Ballast Tanks**

(3) **Converted Tanks on Combination Carriers** *On combination carriers, dual purpose oil/ballast tanks that have been converted to ballast tanks provided the ballast tanks are: 1) permanently disconnected from the oil cargo system; 2) connected to an independent ballast system; and 3) solely allocated to carry ballast.*

(4) **Provision Rooms/Bonded Stores** *Provision rooms for crew or passengers and bonded stores for crew.*

(5) **Fishing Gear** *In fishing vessels, spaces used exclusively for storing fishing gear.*

(6) **Passenger Accommodations** *Spaces utilized for passenger accommodations.*

(7) **Deck Cargo** *Any deck cargo carried aboard the vessel.*

69.63 NET TONNAGE

Net tonnage (NT) is determined by the formula:

$$NT = K_2 V_c (4d/3D)^2 + K_3 (N_1 + N_2/10)$$

in which,

V_c = total volume of cargo spaces (*excluding passenger spaces*) in cubic meters

$K_2 = 0.2 + 0.02 \log_{10} V_c$

$K_3 = 1.25 [(GT + 10,000) / 10,000]$

D = molded depth amidships in meters, as “molded Depth” is defined in § 69.53

d = molded draft amidships in meters, as “molded draft” is defined in § 69.53

N_1 = number of passengers in cabins with not more than eight berths, as “passenger” is defined in § 69.53

N_2 = number of other passengers, as “passenger” is defined in § 69.53

GT = gross tonnage as determined under § 69.57

and with the following restrictions:

N_1 plus N_2 must equal the total number of passengers the vessel is permitted to carry as indicated on the Ship’s Passenger Certificate (*i.e. SOLAS Certificate or similar document*). If N_1 plus N_2 is less than 13, both N_1 and N_2 are zero.

$(4d/3D)^2$ must not be greater than unity.

$K_2 V_c (4d/3D)^2$ must not be less than **0.25 GT**

NT must not be less than **0.30 GT**.

The final figures determined by the above formula and stated on the appropriate tonnage certificate(s) should be given in rounded down figures without decimals.

69.65 CALCULATION OF VOLUMES

(a) **NAVAL ARCHITECTURAL PRACTICES**

Volumes V and V_c used in calculating gross and net tonnages, respectively, must be measured and calculated according to accepted naval architectural practices for the spaces concerned.

(b) **HULL VOLUME**

The volume of the hull below the upper deck is determined as follows. *As an alternative to §69.65(b)(1)-(4) below, any method that is accepted naval architectural practice may be used to determine the volume of the hull below the upper deck.*

- (1) **Existing Stations** If the number and location of sections originally used in making other calculations which relate to the form of the vessel (such as displacement volumes and center of buoyancy) are reasonably available, Simpson's first rule, *or any other integration method that is acceptable naval architectural practice*, may be applied using those sections.
- (2) **Moorsom Method** If the number and location of stations originally used are not reasonably available or do not exist and the hull is of conventional design with faired lines, Simpson's first rule may be applied using a number and location of stations not less than those indicated in §69.109(g)(1). *Faired lines in this context means that the hull does not have chines, longitudinal discontinuities, or any other knuckles or similar discontinuities that would render use of Simpson's first rule inappropriate.*
- (3) **Standard Geometric Shape** If the hull is of standard geometric shape, a simple geometric formula that yields a more accurate volume may be used.
- (4) **Hull Not Fair** If the lines of the hull are not fair, the volume may be measured by using a combination of methods under this section, *or any other method, provided that the volume so measured is calculated according to acceptable naval architectural practices.*

(c) **DECK STRUCTURE VOLUME**

The volume of structures above the upper deck may be measured by applying the superstructure provisions in §69.113 (if applicable) or by any accepted method or combinations of methods. *In general, the same longitudinal and vertical integration schemes that are accepted naval architecture practices used in the calculation of hull volumes may be used for deriving volumes of deck structures.*

(1) **Volume Calculation Methods.** Structures may be modeled in parts using several mathematical methods such as:

(i) **Simple geometric shape formulae for areas or solids.** Geometric shapes may be used to model structures or their components only if the dimensions and form are identical.

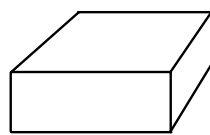

$$V = LBD$$



$$V = \pi r^2 L$$



$$V = 4\pi r^3/6$$

(ii) **Mechanical or electronic instrumentation.** Planimeters or electronic digitizing may be used to calculate complex area shapes that render manual integration impracticable.

(iii) **Two-dimensional integration.** Two-dimensional integration first determines the sectional area and then multiplies the area by the depth or thickness to derive the volume. It can be used for prismatic forms where the cross-sectional shape, dimensions and area remain the same at all levels of thickness. The cross-sectional area may be modeled using simple geometric area formulae, in whole or in parts, and then multiplied by thickness to derive the volume. If the cross-sectional area is not a standard geometric shape, it should be integrated in whole or in parts.

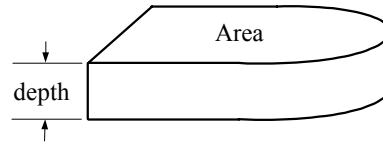

(iv) **Three-dimensional integration.** Three dimensional integration is used for complex shapes which cannot be modeled by simple geometric formulae or two-dimensional integration. In this method, area integration (two-dimensional) is followed by volume integration.

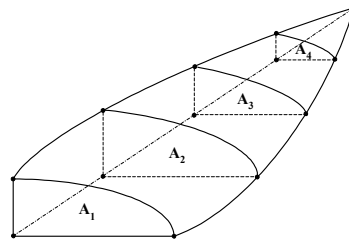

Any mathematical method may be used, provided it accurately models the configuration being measured. Any appropriate area or volume integration method may be used, such as Simpson's First Rule, Trapezoidal Rule, etc. Also, areas or volumes may be integrated along any axis (vertical, horizontal and/or longitudinal) on the vessel as convenient to capture the actual total structure volume.

(2) **Simpson's First Rule.** Simpson's First Rule is intended for integrating areas or volumes under parabolic (second order) curves. When using Simpson's Rule, the end ordinates (those at the "1" multiplier) and the dividing ordinates (those at the "2" multiplier) should coincide with discontinuities and points of inflection in the structure. Discontinuities include breakpoints (knuckles) and steps. Inflections are changes in the direction of a faired curve. Intervals (distances between ordinates) should be adjusted to provide additional ordinates to define extreme curves (rapid changes in the shape).

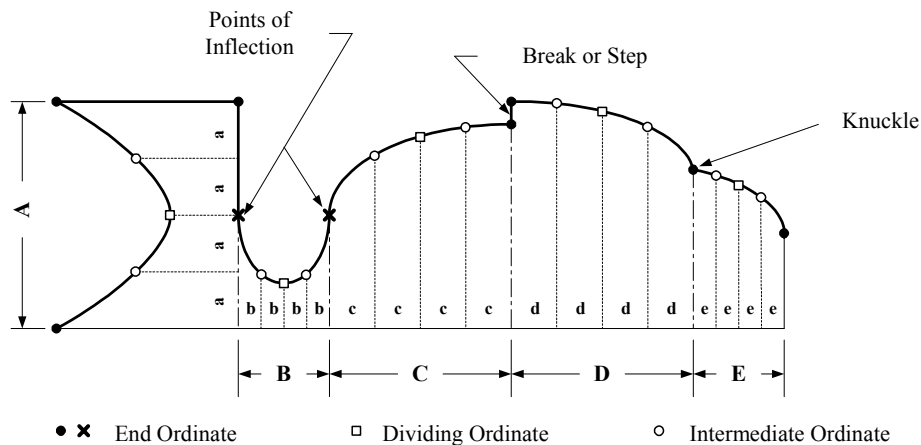

- (3) **Moorsom Method.** *The Moorsom method (a variation of Simpson's First Rule described in 69.109, 69.111 and 69.113) is not an acceptable method for most convention system applications. This is because there are no provisions for placing end or dividing ordinates on discontinuities or inflections or adjustment of intervals (ordinate spacing) for extreme curves, as should be done, unless the structure is properly modeled or measured in parts.*
- (4) **Trapezoidal Rule.** *If the Trapezoidal Rule is used to integrate areas under curves, smaller intervals should be used in comparison to those under Simpson's Rule to increase accuracy. The placement of ordinates is not critical except that they must be coincident with discontinuities (chines, breaks, knuckles, etc.)*

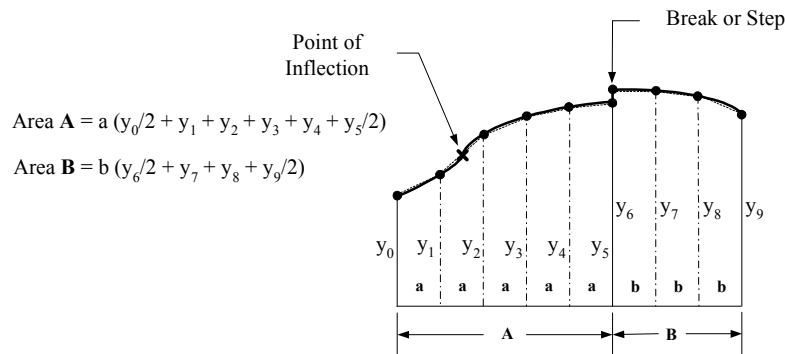

- (5) **Division by Tiers.** *Volume accounting does not have to be categorized or broken down by tiers or levels as implied on tonnage certificates. Volumes may be determined by individual structures or erections as necessary and may be itemized as such, in lieu of tier levels.*
- (6) **Restrictions on using § 69.113.** *The two-dimensional integration scheme described in § 69.113 may be used for convention measurement only if the:*

(i) *sides of the tier are "wall-sided" with no curved flare or tumble-home,*

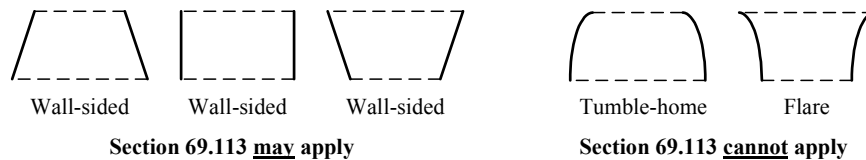

(ii) *deck in plan view does not have discontinuities, inflection points (unless they coincide with end or dividing ordinates) or extreme curves, which would render the suggested Moorsom integration scheme inappropriate, unless the structure is properly modeled or measured in parts.*

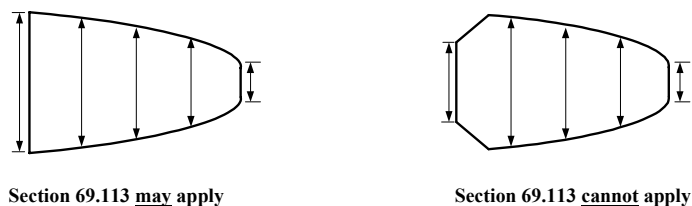

(iii) decks are parallel.

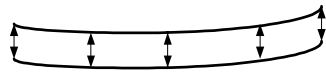

Section 69.113 may apply



Section 69.113 may apply

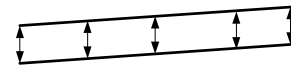

Section 69.113 may apply

(d) TERMINATION OF MEASUREMENTS

Measurements must be taken regardless of the fitting of insulation or the like -

- (1) To the inner side of the shell of the hull (or to the inner side of the structural boundary plating for deck structures) in vessels constructed of metal; and
- (2) To the outer surface of the shell of the hull (or to the inner side of the structural boundary surfaces for deck structures) in all other vessels.

(e) MEASURING CARGO SPACES

When determining the volume of a cargo space, measurements must be taken without consideration for insulation, sparring, or ceiling fitted within the space. For vessels which have permanent independent cargo tanks constructed within the vessel, (e.g. gas carriers) the volume to be included should be calculated to the structural boundary of such tanks, irrespective of insulation which may be fitted to the tank boundary.

(f) PRECISION OF MEASUREMENTS

Measurements must be to the nearest one-twentieth of a foot (english units), or the nearest centimeter (metric units).

(g) CALCULATION WORKSHEET

Calculations must be made on a worksheet and must be sufficiently detailed to permit easy review. The measurement procedures used must be identified on the worksheet. If calculations are performed using computer software, printed output showing a description of all dimensional information upon which volumes are based can be substituted for a worksheet. For convenience, when calculating the volume of any enclosed space which includes spaces excluded under § 69.61, it is acceptable to calculate the volume for the entire space and then subtract out the volumes of any associated excluded spaces.

(h) SPACES IGNORED FROM VOLUME CALCULATIONS

The following spaces are ignored from volume calculations:

- (1) Air Trunks Less Than 1m² Air trunks having a cross-sectional area not exceeding one square meter.

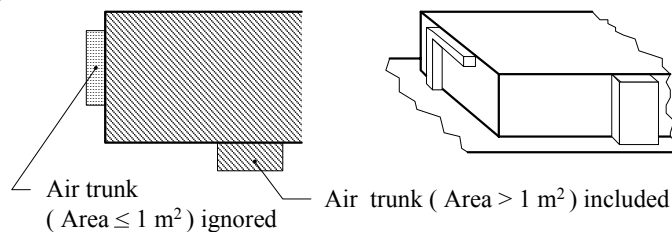

- (2) Volumes Less Than 1m³ Enclosed spaces having a volume not exceeding one cubic meter.

- (3) **Mast-Like Structures** *Masts, kingposts, cranes (including gantry and mobile cranes), and container support structures which are located above the upper deck and are separated on all their sides from other enclosed spaces, provided the internal volumes are inaccessible.*
- (4) **Unenclosed Machinery** *Machinery that is not enclosed by a housing, or similar protective structure (e.g. an unhoused deck winch). Rudders, propeller shafting, propellers, azimuthing propulsion units, and similar movable propulsion, steering or trimming devices are considered machinery in this context.*
- (5) **Appendages Not Having Enclosed Volume** *Appendages which do not have enclosed volume, such as bearing struts, solid bilge keels, open frameworks and fenders.*

69.67 MARKING OF CARGO SPACES

Cargo spaces used in determining volume (V_c) for calculating net tonnage must be permanently marked with the letters "CC" (cargo compartment) which are at least four inches in height and positioned so as to be visible at all times. *The marking specifications in 69.119(p)(3) may be used as guidelines.*

69.69 ISSUANCE OF AN INTERNATIONAL TONNAGE CERTIFICATE (1969)

On request of the vessel owner, an International Tonnage Certificate (1969) is issued for a vessel measured under this subpart that is 79 feet or more in registered length and that will engage on a foreign voyage. The Certificate is issued to the vessel owner or master and must be maintained on board the vessel when it is engaged on a foreign voyage.

69.71 CHANGE OF NET TONNAGE

This section provides general requirements on parameters that affect net tonnage, including restrictions governing when newly assigned net tonnages can take effect following a change in net tonnage. The restrictions are intended to prohibit a vessel owner from having lower net tonnages assigned during voyages for which a vessel is unladen (e.g. by having a lower load line assigned for that voyage).

(a) NET TONNAGE INCREASES

When a vessel is altered so that the net tonnage is increased, the new net tonnage must be applied immediately.

(b) VESSEL WITH DIFFERENT LOAD LINE ASSIGNMENTS

A vessel concurrently assigned load lines under both the International Convention on Load Lines (parts 42, 44, 45, or 47 of this chapter) and either the International Convention for the Safety of Life at Sea (SOLAS) (part 46 or 47 of this chapter) or other international agreement must be assigned only one net tonnage. The net tonnage assigned must be the net tonnage applicable to the load line assigned under the International Convention on Load Lines or SOLAS for the trade in which the vessel is engaged.

(c) NET TONNAGE DECREASES

When a vessel is altered so that the net tonnage is decreased or the vessel's trade is changed so that the load line assigned for that trade under paragraph (b) of this section is no longer appropriate and results in a decrease in its net tonnage, a new International Tonnage Certificate (1969) incorporating that net tonnage may not be issued until twelve months after the date on which the current Certificate was issued. However, if one of the following apply, a new Certificate may be issued immediately:

- (1) When the vessel is transferred to the flag of another nation.
- (2) The vessel undergoes alterations or modifications which the Coast Guard deems to be of a major character, such as the removal of a superstructure which requires an alteration of the assigned load line. *For purposes of applying this criteria, any modifications to the extent that the vessel would require remeasurement are considered to be "of a major character".*

69.73 VARIANCE FROM THE PRESCRIBED METHOD OF MEASUREMENT

(a) NOVEL VESSEL DETERMINATION

When application of this subpart to a novel type vessel produces unreasonable or impractical results, the Commandant may determine a more suitable method of measurement.

(b) SUBMITTAL OF DETERMINATION REQUESTS

Requests for a determination must: 1) be submitted to the Commandant, 2) explain the problem, and 3) include plans and sketches of the spaces in question.

69.80 OPEN-TOP CONTAINERSHIPS

The provisions of the 1969 Tonnage Convention should be applied to open-top containerships subject to the following unified interpretations:

(a) UPPER DECK DETERMINATION

In a vessel which is exempted from the requirements to fit weathertight hatch covers on the uppermost deck exposed to weather and sea, as in an open-top containership, the upper deck should be taken as that deck which would have been determined as if such hatch covers had been fitted.

(b) ENCLOSED SPACES

An opening in a deck such as the absence of hatch covers should not preclude a space from being treated as an enclosed space.

(c) TREATMENT OF SHELTER ABOVE CONTAINERSTACKS

In the case of open-top containerships having movable non-load-bearing covers (shelter) of light construction resting on the container guides, the space above the hatch coamings up to the covers does not qualify as an excluded space according to regulation 2(5) of the Tonnage Convention. For this particular design, however, an exception can be made in accordance with regulation 1(3). The space can be excluded provided that this type of vessel meets the requirements of an open-top containership without such covers.

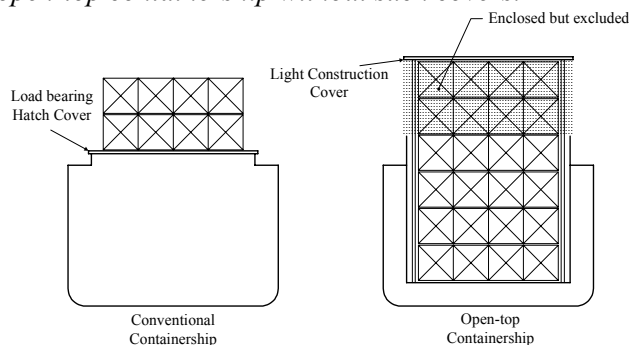

69.81 Offshore Supply Vessels (OSV's)

The uncovered cargo deck space on an OSV is not considered an enclosed space under the provisions of §69.73(a), notwithstanding the presence of bulwarks or other enclosing structures that exceed the 5 foot height criteria of §69.59. In this context, the cargo deck space is defined as the open space on the main deck aft of the forecastle that is exposed to weather and used for stowage of deck cargo loads and/or processing equipment. This determination applies to all self-propelled vessels that regularly carry goods, supplies, individuals in addition to the crew, or equipment in support or exploration, exploitation, or production of offshore mineral or energy resources.

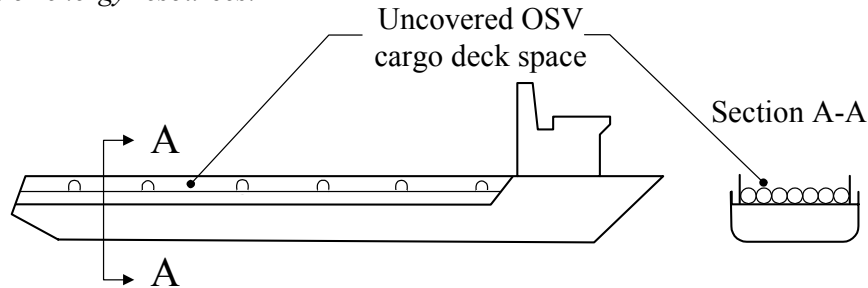

69.85 REDUCED GROSS TONNAGE

IMO Resolution A.747(18) and IMO TM.5/Circ.4 provide for the calculation of a Reduced Gross Tonnage (GT_r) for qualifying vessels upon request of the vessel owner. Reduced Gross Tonnage is intended to encourage favorable economic treatment of vessels whose designs incorporate specific features. For applicable vessels, a remark is included on a qualifying vessel's International Tonnage Certificate (1969), citing the Reduced Gross Tonnage. The remark includes the statement that the Reduced Gross Tonnage may be used for the "calculation of tonnage based fees." Reduced Gross Tonnage is calculated as follows:

(a) VESSELS WITH QUALIFYING SEGREGATED BALLAST TANKS

The formula for Reduced Gross Tonnage of a vessel with qualifying segregated ballast tanks is provided below. To be considered qualifying segregated ballast tanks, the tanks must have a separate ballast pumping and piping system arranged for the intake and discharge of ballast water from and to the sea only. In addition, there must be no piping connections from segregated ballast tanks to the fresh water system, and the tanks must not be used for the carriage of any cargo or for the storage of ship's stores or material:

$$GT_r = GT - K_1 V_b$$

in which:

GT is as calculated in §69.57

K_1 is as calculated in §69.57

V_b is the total volume of qualifying segregated ballast tanks, calculated in cubic meters.

(b) OPEN-TOP CONTAINERSHIPS

The formula for Reduced Gross Tonnage of an open-top containership is provided below. Reduced Gross Tonnage may be calculated in accordance with this formula only if the vessel's Gross Tonnage (GT) as calculated in §69.57 is 30,000 or less.

$$GT_r = GT [1 - 0.000007(30000 - GT)]$$

in which:

GT is as calculated in §69.57

SIMPLIFIED MEASUREMENT SYSTEM (46 CFR 69 SUBPART E)

69.201 PURPOSE

This subpart prescribes the procedures for measuring a vessel under the Simplified Measurement System described in 46 U.S.C. chapter 145, subchapter III.

69.203 DEFINITIONS

As used in this subpart, and in Coast Guard Form CG-5397 under § 69.205 –

Multi-Hull Vessel means a vessel with more than one distinct hull. To be considered a distinct hull, the hull must connect to another hull only with structure that is not a part of the vessel's buoyant hull envelope.

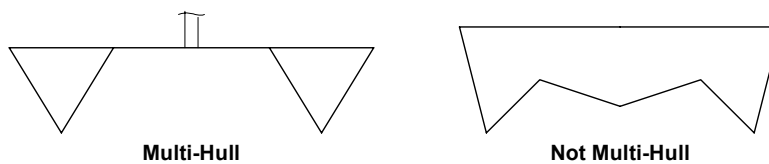

OVERALL BREADTH means the horizontal distance taken at the widest part of the hull, excluding rub rails, from the outboard side of the skin (outside planking or plating) on one side of the hull to the outboard side of the skin on the other side of the hull.

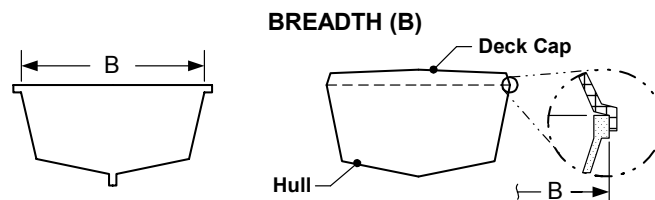

OVERALL DEPTH means the vertical distance taken at or near midships from a line drawn horizontally through the uppermost edges of the skin (outside planking or plating) at the sides of the hull (excluding the cap rail, trunks, cabins, and deckhouses) to the outboard face of the bottom skin of the hull, excluding the keel. Depth is measured at amidships for all cases except those in which there is a longitudinal discontinuity in the deck that occurs within 5% of the overall length on either side of amidships. In such cases, the greater depth is used. For a vessel that is designed for sailing and has a keel faired to the hull, the keel is included in the "overall depth" if the distance to the bottom skin of the hull cannot be determined reasonably (See § 69.201(a)(5)).

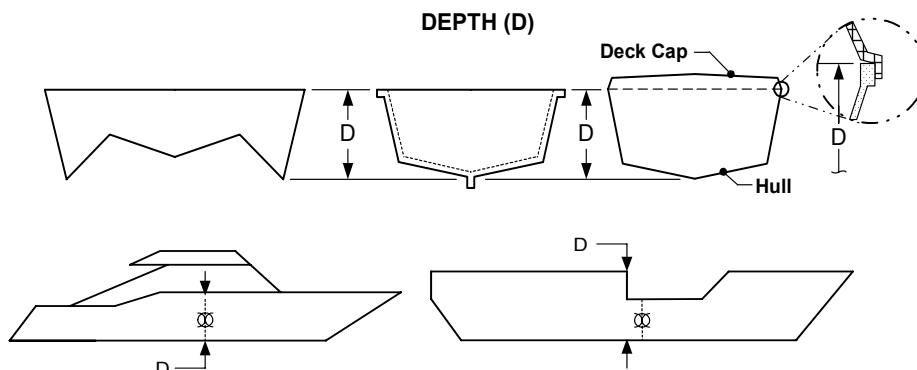

OVERALL LENGTH means the horizontal distance between the outboard side of the foremost part of the stem and the outboard side of the aftermost part of the stern, excluding rudders, outboard motor brackets, and other similar fittings and attachments. *Also excluded from length are non-buoyant attachments such as bulwarks, bowsprits, overhanging decks, swim platforms and stern-wheel supports. Buoyant hull structures both fixed and removable are included in the overall length, and consequently in tonnage.*

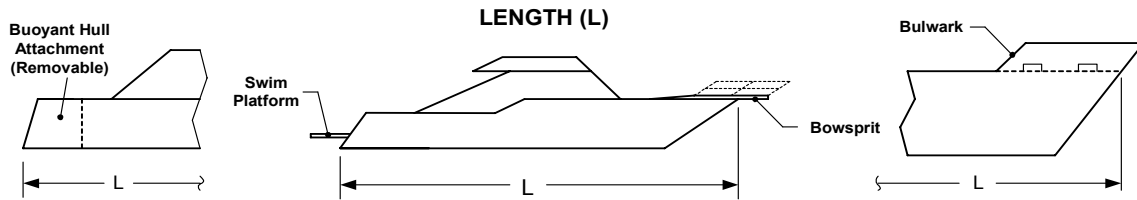

AMIDSHIPS or **MIDSHIPS** means the midpoint of the overall length.

Note: The term “overall” as used above for breadth, depth and length differs from the naval architectural term of art for which all extended fittings of the hull are included.

REGISTERED BREADTH means –

- (a) For a single-hull vessel, the vessel’s overall breadth; and
- (b) For a multi-hull vessel, the horizontal distance taken at the widest part of the complete vessel between the outboard side of the skin (outside planking or plating) on the outboardmost side of one of the outboardmost hulls (e.g., port hull) to the outboard side of the skin on the outboardmost side of the other outboardmost hull (e.g., starboard hull), excluding rubrails.

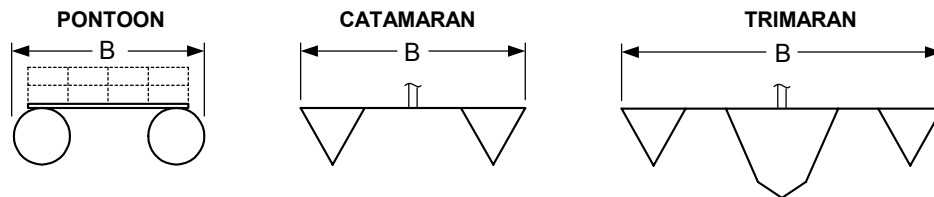

REGISTERED DEPTH means –

- (a) For a single-hull vessel, the vessel’s overall depth; and
- (b) For a multi-hull vessel, the overall depth of the deepest hull.

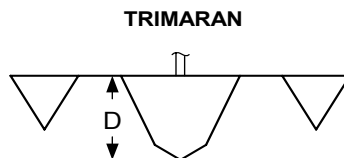

REGISTERED LENGTH means –

- (a) For a single-hull vessel, the vessel’s overall length; and
- (b) For a multi-hull vessel, the horizontal distance between the outboard side of the foremost part of the stem of the foremost hull and the outboard side of the aftermost part of the stern of the aftermost hull, excluding fittings and attachments.

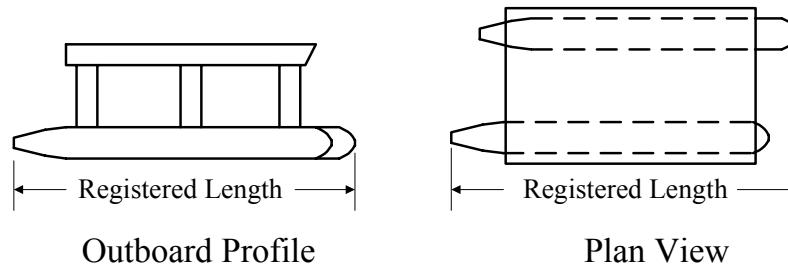

STEM means the foremost boundary of the buoyant hull envelope.

STERN means the aftermost boundary of the buoyant hull envelope.

VESSEL DESIGNED FOR SAILING means a vessel which has the fine lines of a sailing craft and is capable of being propelled by sail, whether or not the vessel is equipped with an auxiliary motor, a decorative sail, or a sail designed only to steady the vessel.

69.205 APPLICATION FOR MEASUREMENT SERVICES

To apply for measurement under the Simplified Measurement System, the owner of the vessel must complete either an Application for Simplified Measurement (form CG-5397), or a Builder’s Certification and First Transfer of Title (form CG-1261) which has the information in Part III “Dimensions” completed, and submit it to the National Vessel and Documentation Center (NVDC). *The preceding sentence will be reworded in the next revision of the regulations to state that a vessel owner must submit either an Application (form CG-5397), or a copy of a Builder’s Certificate (CG-1261). The former is completed by the vessel owner, and the latter by the vessel builder or manufacturer.*

69.207 MEASUREMENTS

- (a) All lengths and depths must be measured in a vertical plane at centerline and breadths must be measured in a line at right angles to that plane. All dimensions must be expressed in feet and inches to the nearest half inch or in feet and tenths of a foot to the nearest .05 of a foot.

Length is measured in a vertical (longitudinal) plane at the centerline of the hull(s). Depth is measured in a vertical (transverse) plane at right angles to the centerline at or near amidships. Breadth is measured in a vertical (transverse) plane at right angles to the centerline at the widest part of the hull.

- (b) For a multi-hull vessel, each hull must be measured separately for overall length, breadth, and depth and the vessel as a whole must be measured for registered length, breadth, and depth.
- (c) The Coast Guard may verify dimensions of vessels measured under this subpart.

69.209 CALCULATION OF TONNAGES

(a) GROSS TONNAGE

- (1) Except as in paragraph (a)(2) through (a)(5) of this section, the gross tonnage of a vessel designed for sailing is one-half of the product of its overall length, overall breadth, and overall depth (LBD) divided by one hundred (i.e., 0.50 LBD/100), and the gross tonnage of a vessel not designed for sailing is 0.67 LBD/100.

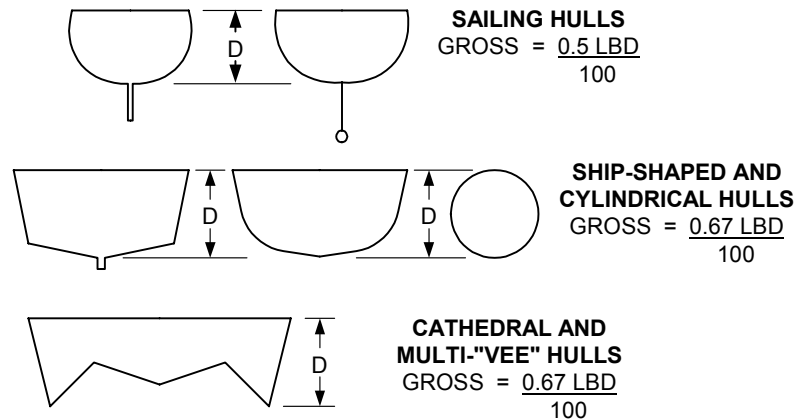

- (2) The gross tonnage of a vessel with a hull that approximates in shape a rectangular geometric solid (barge-shape) is 0.84 LBD/100.

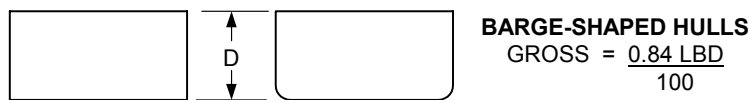

- (3) The gross tonnage of a multi-hull vessel is the sum of all the hulls as calculated under this section.

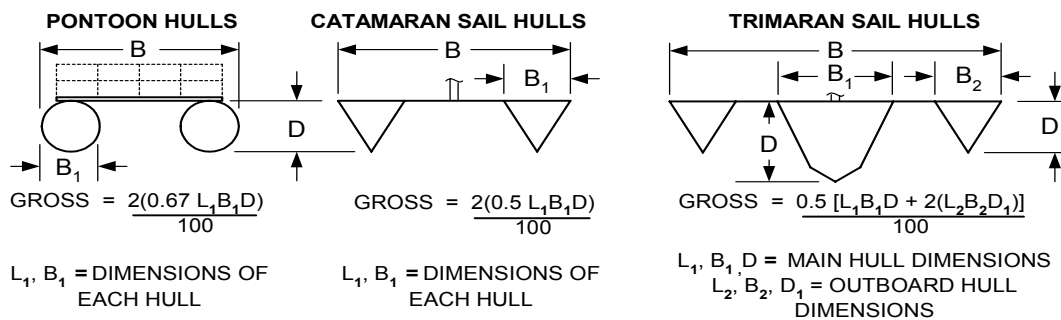

- (4) If the volume of the principal deck structure of a vessel is as large as, or larger than, the volume of the vessel's hull, the volume of the principal deck structure in tons of 100 cubic feet is added to the tonnage of the hull to establish the vessel's gross tonnage. The volume of the principal deck structure of a vessel is determined by the product of its average dimensions.

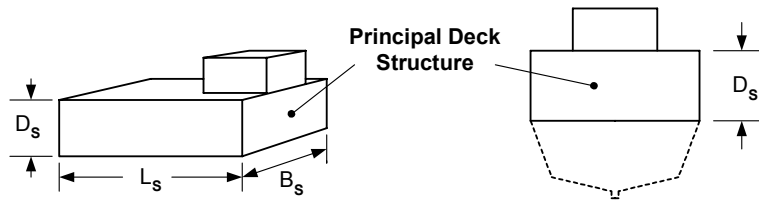

$$\text{PRINCIPAL DECK STRUCTURE TONNAGE} = \frac{L_s B_s D_s}{100}$$

- (5) If the overall depth of a vessel designed for sailing includes the keel, only 75 percent of that depth is used for gross tonnage calculations.



- (6) The gross tonnage of a drydock having wingwalls that are part of the buoyant hull envelope is calculated assuming the depth includes the height of the wingwalls and applying a shape coefficient of 0.84 as follows:

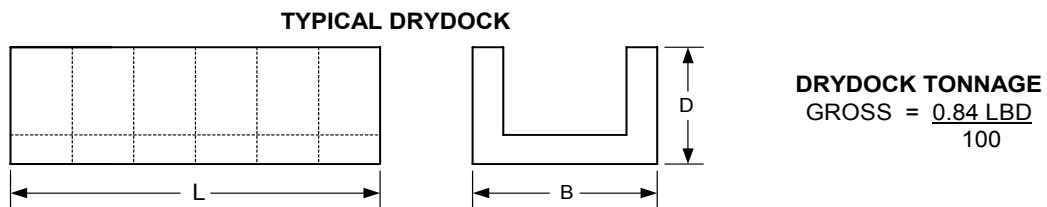

(b) NET TONNAGE

- (1) For a vessel having propelling machinery in its hull –

- (i) The net tonnage is 90 percent of its gross tonnage, if it is a vessel designed for sailing; or

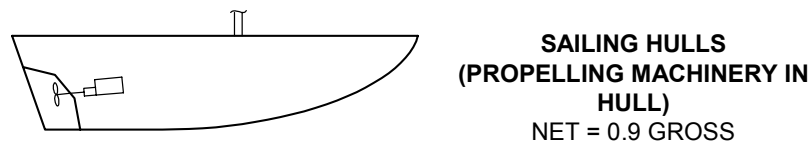

(ii) The net tonnage is 80 percent of its gross tonnage, if it is not designed for sailing.

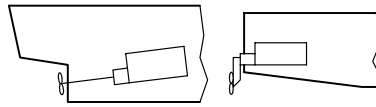

**SHIP-SHAPED, PONTOON AND
BARGE HULLS
(PROPELLING MACHINERY IN
HULL)
NET = 0.8 GROSS**

(2) For a vessel having no propelling machinery in its hull, the net tonnage is the same as its gross tonnage.

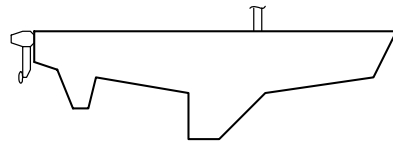

**SAILING HULLS
(NO PROPELLING MACHINERY IN
HULL)
NET = GROSS**

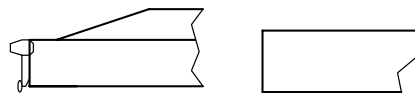

**SHIP-SHAPED, PONTOON AND
BARGE HULLS
(NO PROPELLING MACHINERY
IN HULL)
NET = GROSS**

(c) **TONNAGE OF NOVEL CRAFT** *The determination of tonnage for novel craft should be referred to the USCG Marine Safety Center. Examples of novel craft are Wing-in-Ground (WIG), SLICE and Small Waterplane Twin Hull (SWATH) craft.*

GRANDFATHERING PROVISIONS

A.1 PURPOSE

The purpose of this Appendix is to authorize specific circumstances under which interpretations of the tonnage regulations may be applied that predate the interpretations promulgated by changes to this MTN.

A.2 DISCUSSION

This MTN is intended to provide sufficient interpretive information to enable correct and consistent application of the tonnage measurement regulations. While the MSC's goal is to ensure the interpretative information is clear and keeps pace with the evolution of vessel designs, the MSC recognizes that designers and measurement organizations may apply reasonable interpretations of the regulations that are subsequently superseded by changes to the MTN. The MSC's position is that once tonnages have been certified using reasonable interpretations of the regulations, it is not necessary to remeasure a vessel for the purpose of applying later interpretations, unless requested by the vessel's owner. Further, in order to provide relief to owners who are having vessel's designed or redesigned on the basis of interpretations that are subsequently superseded, the MSC considers that grandfathering should be extended to such vessels, and to identical sister vessels.

A.3 GRANDFATHERING AUTHORIZATION

Interpretations of the tonnage regulations that immediately predate the interpretations promulgated by a change to this MTN may be applied at the option of the vessel's owner, for vessels in any of the following three categories:

- (a) A vessel for which tonnages have not been certified and which was contracted for on or before the date of the MTN change.*
- (b) A vessel for which tonnages have been certified, but which has undergone modifications that were contracted for on or before the date of the MTN change.*
- (c) A sister vessel that is identical from the standpoint of tonnage measurement to a vessel described in either Section A.3(a) or Section A.3(b) above.*

A vessel for which tonnages have already been certified should not be remeasured for the purpose of applying the latest interpretations of this MTN, except upon request by the vessel's owner and at the owner's expense.

A.4 CONSIDERATION OF OTHER VESSELS

The MSC recognizes that there may be unique circumstances under which grandfathering should be extended to vessels other than those described in Section A.3 above. The MSC will give consideration to requests to extend grandfathering to other vessels. Such requests must be made in writing to the Commanding Officer, MSC, and must be accompanied by information detailing the specific stage of design and/or construction of the vessel on the date of the MTN change that promulgated the superseded interpretations.

(Page intentionally left blank)

CHANGES IN MTN 01-99 CH-3

Subpart B – Convention Measurement

1. **Section 69.59** This section was revised to reference new Section 69.81 regarding cargo deck space treatment of offshore supply vessels (OSV's).
2. **Section 69.81** This new section was added to reflect the Coast Guard's recent decision to ignore from measurement uncovered cargo deck spaces on OSV's under the novel craft provisions of Section 69.73(a).
3. **Section 69.209(a)(3)** The illustrative figure for the trimaran was revised to show the center hull breadth dimension (B1).